

MOBIL PLASTIC S.P.A.



**Mobil Plastic®**

HO.RE.CA.

**Catalogo  
Generale  
2023**

HO.RE.CA. - Catalogo Generale

**Mobil Plastic®**



[www.mobilplastic.it](http://www.mobilplastic.it)



MOBIL PLASTIC S.P.A. - Via Robbio, 31 - 27030 CONFENZA (PV)  
Tel. 0384.674692 (4 linee r. a.) - Fax: 0384.674696 - E-Mail: [info@mobilplastic.it](mailto:info@mobilplastic.it)

# Indice

Catalogo 2023



## CONTENITORI PER ALIMENTI E MILLEUSI

FOOD AND MULTIPURPOSE CONTAINERS

Pag. 8



## CONTENITORI E TRASPORTO LIQUIDI

LIQUID STORAGE AND TRANSPORT

Pag. 26



## ACCESSORI DA CUCINA E LAVORAZIONE ALIMENTI

KITCHEN ACCESSORIES AND  
FOOD PROCESSING

Pag. 32



## PULIZIA & RACCOLTA DIFFERENZIATA

CLEANING & WASTE COLLECTION

Pag. 44



# DOVE SIAMO



Via Robbio 31,  
27030 Confienza (PV)  
ITALIA



Google Map



Shoot and go !



## COME RAGGIUNGERCI

Mobil Plastic s.p.a. è ubicata in località CONFIENZA (PV) a ca. 15 km da Novara, Vercelli e Mortara.

In posizione strategica rispetto alle grandi linee di comunicazione, la si può raggiungere sia dalla A4 (Torino – Venezia) uscita Novara Est, che dalla A21 (Piacenza – Torino) uscita Voghera, che dalla A26 (Gravellona – Voltri) uscita Vercelli Est.

## HOW TO REACH US

Mobil Plastic s.p.a. is located in CONFIENZA (PV) about 15 km from Novara, Vercelli and Mortara.

In a strategic position with respect to the main transport network, it can be reached either from the A4 (Turin-Venice) Novara Est exit or from the A21 (Piacenza-Turin) Voghera exit or from the A26 (Gravellona-Voltri) Vercelli Est exit.



# About



## 1968

Verso la fine degli anni '60, gli anni che hanno segnato la storia industriale dell'Italia, e più precisamente nel 1968, viene fondata l'azienda Mobil Plastic.

Fin dai primi anni il successo è stato immediato, prima in Italia, per poi espandersi nei mercati europei di riferimento con la presenza a tutte le Fiere Internazionali più importanti del settore.

In the late '60s and more precisely in 1968, years that marked the industrial history in Italy, Mobil Plastic started its activity. Since the early years, the company has made an instant success, first of all in Italy and then also in the most important European markets, attending all the best known international exhibitions in its sector.



## 1997

Nel pieno della sua continua espansione, nel 1997 avviene il passaggio generazionale alla guida della società. Subentrano infatti i figli del fondatore, Alberto e Pierangelo, i quali fin da subito pongono le basi per una ulteriore crescita applicando una rinnovata politica aziendale unitamente a moderne strategie commerciali.

Nuove ed innovative tecnologie di produzione ed una attenta e mirata ricerca e diversificazione, consentono, pochi anni dopo, l'apertura di una nuova unità produttiva all'estero.

In 1997, in the middle of its continuous expansion, the company generational handover took place. The founder's sons, Alberto and Pierangelo, chose to follow an updated company policy together with new business strategies. Few years later, thanks to new production technologies, a focused research and diversification approaches, Mobil Plastic started a new production unit abroad.

## 2008

Il 2008 segna una ulteriore ed importante svolta con l'acquisizione di una storica azienda Italiana molto conosciuta con il marchio SSS, attiva da oltre 40 anni nel settore casalingo, enologico, industriale e più di recente anche nel settore ecologico.

L'importante investimento vede raddoppiare le dimensioni aziendali e i volumi di produzione imponendo alla società Mobil Plastic nuovi obiettivi, nuove strategie e nuove sfide commerciali.

2008 marks a further important turning point thanks to the takeover of a well-known Italian company famous for the "SSS" brand, which has worked for more than 40 years in the enology, households, industrial and, more recently, eco-friendly sector.

This important investment doubles the company dimensions and the production volumes, imposing to Mobil Plastic new goals, new strategies and new business challenges.



## 2018

Mobil Plastic compie 50 anni ed è sempre più una realtà leader nel suo settore merceologico. E' affermata in tutta Europa con lo spirito dell'innovazione, di nuovi processi produttivi, del web e dei nuovi mercati; si apre una nuova era e nasce la nuova immagine della società in linea con i tempi. Ancora una volta, Mobil Plastic pone le basi per una ulteriore evoluzione e crescita e si propone al mercato come "partner" serio, affidabile e moderno.

Mobil Plastic celebrates 50 years of activity and nowadays it is a leading company on its market. It is a well-known company all over Europe thanks to its spirit of innovation, its tendency for new production processes, web market and other sectors. This is the beginning of a new era with a contemporary and up-to-date corporate image.

## 2022

Anni difficili, di pandemia che stravolgono le abitudini, i valori e le regole dei mercati in tutto il mondo.

Mobil Plastic ancora una volta si distingue per versatilità, resilienza e reattività ai cambiamenti consolidando e crescendo ulteriormente.

Nuovi importanti investimenti in linea con le direttive INDUSTRIA 4.0 e la ricerca e l'utilizzo di nuove tecnologie e processi produttivi con materie prime GREEN a basso impatto. Mobil Plastic guarda al futuro con sano ottimismo, consapevole del proprio know how e pronta ad affrontare ed ad imporsi ai mercati di riferimento in tutta Europa

Difficult years, years of pandemics that upset the habits, values and rules of markets all over the world. Mobil Plastic once again stands out for its versatility, resilience and reactivity to changes, consolidating and growing further.

New important investments in line with the INDUSTRY 4.0 directives and the research and use of new technologies and production processes with low-impact GREEN raw materials.

Mobil Plastic looks to the future with healthy optimism, aware of its know-how and ready to face and impose itself on the reference markets throughout Europe

# Ambiente

## Mobil Plastic per l'Ambiente

Mobil Plastic è impegnata in prima linea investendo in risorse e tecnologie per sostenere una filiera produttiva e logistica volta a salvaguardare, tutelare e rispettare l'ambiente e il mondo che ci circonda. Largo utilizzo di materie prime provenienti da POST CONSUMO, riciclate e riciclabili al 100% rendono i prodotti Mobil Plastic a basso impatto ambientale e in linea con una concezione "GREEN" seguendo e applicando direttive delle principali organizzazioni mondiali sull'ambiente e più in generale su concetti di "Economia circolare". Anche gli approvvigionamenti da fornitori esterni sono controllati e scelti accuratamente in base al concetto di "KM 0" per diminuire al massimo il trasporto e l'inquinamento ambientale. Materiali di nuova applicazione per il settore dello stampaggio ad iniezione sono utilizzati da Mobil Plastic, come ad esempio il "PET" proveniente dalla filiera del riciclo bottiglie di plastica. Mobil Plastic garantisce per ogni singolo suo prodotto, la massima attenzione alla qualità, alla durata e alla produzione a basso impatto ambientale.

## Autonomia Energetica

Grazie ai nostri impianti fotovoltaici siamo in grado di generare autonomamente buona parte dell'energia necessaria alla nostra produzione, risparmiando così preziose risorse ambientali senza inquinare.

## Mobil Plastic è Corporate Golden Donor FAI

Mobil Plastic è membro Corporate Golden Donor FAI, associazione conosciuta in tutto il mondo. Essere membro Corporate Golden Donor FAI è segno di eccellenza ed è un modo concreto per contribuire ad una causa importante che Mobil Plastic abbraccia da anni con entusiasmo.



Noi sosteniamo il FAI

## Mobil Plastic for the Environment

*Mobil Plastic is committed to the forefront by investing in resources and technologies to support a production and logistics chain aimed at safeguarding, protecting and respecting the environment and the world around us. Wide use of raw materials from POST-CONSUMPTION, recycled and 100% recyclable, make Mobil Plastic products with low environmental impact and in line with a "GREEN" concentration, following and applying directives from world organizations on the environment and more generally on concepts of "Circular Economy".*

*Even supplies from external suppliers are controlled and chosen on the basis of the "KM 0" concept to minimize transport and environmental pollution. Newly applied materials for the injection molding sector are used by Mobil Plastic, such as "PET" from the plastic bottle recycling chain. Mobil Plastic guarantees for each single product, the utmost attention to quality, duration and production with low environmental impact.*

## Energy Independence

*Thanks to our photovoltaic systems, we are able to generate electricity, thus saving environmental resources.*

## Mobil Plastic is Corporate Golden Donor FAI

*Mobil Plastic is a FAI Corporate Golden Donor, association known all over the world. To be a FAI Corporate Golden Donor is a sign of excellence and gives a concrete contribution to an important cause that Mobil Plastic has joined for years with enthusiasm.*

## Certificazione 100% GREEN

Tutti gli articoli a catalogo Mobil Plastic contraddistinti da questo simbolo, sono realizzati con materie prime riciclabili o riciclate da post consumo.



## Certificazione plastica seconda vita

Il marchio "PLASTICA SECONDA VITA" (PSV) viene assegnato dall'Istituto IPPR (Istituto Promozione Plastiche Riciclo) dopo attente analisi e procedure.

Si tratta di un sistema di certificazione ambientale dei prodotti ottenuti dal riciclo di rifiuti plastici domestici e post-industriali.

Tale certificazione PSV, la prima in ambito Europeo, esprime un concetto di qualità e rintracciabilità dei materiali impiegati, con riferimento al DM attuativo 203/2003 relativo al GREEN PUBLIC PROCUREMENT e alle normative di riferimento.

Mobil Plastic, anche attraverso il riconoscimento ottenuto di PSV, persegue l'obiettivo di produzione a BASSO IMPATTO AMBIENTALE utilizzando materie prime riciclate da prodotti già utilizzati e contribuendo ad alimentare il ciclo di ECONOMIA CIRCOLARE.

Tutti gli articoli a catalogo MOBIL PLASTIC contraddistinti dal simbolo PSV - plastica 2° vita sono realizzati con materiali idonei e conformi alla certificazione dell'Istituto IPPR ed immessi sul mercato rispettando tutte le normative di riferimento in ambito comunitario e Italiano

## Certificate 100% GREEN

All items on Mobil Plastic catalog, marked with this symbol, are made with recyclable or post-consumer recycled raw materials.

## Certificate second life plastic

The "SECOND LIFE PLASTIC" (PSV) brand is assigned by the IPPR institute (the Italian institute for the promotion of plastic recycling) after a thorough check and procedures. It is an environmental certification system for products obtained from the recycling of domestic and post-industrial plastic waste.

This PSV certification, the first in Europe, expresses a concept of quality and traceability of the materials used, according to the implementing Ministerial Decree 203/2003 relating to green public procurement and the relevant regulations. Mobil Plastic, also through the certification obtained by PSV, pursues the goal of lowest environmental impact production using recycled raw materials from products that have already been used and helping to feed the circular economy cycle.

All the items in the MP catalogue marked with the "PSV - second life plastic" symbol are made with suitable materials and comply with the IPPR institute certification and placed on the market in compliance with all the relevant regulations in Italy and in the European Community.





# CONTENITORI PER ALIMENTI E MILLEUSI

Food and Multipurpose Containers



CASSE 60x40

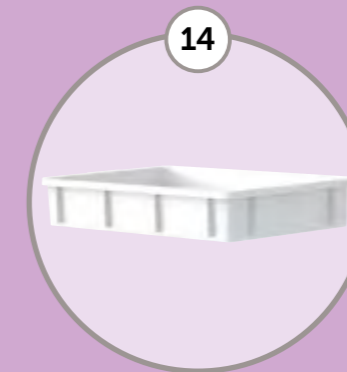

CASSE LIGHT BOX



CASSE MILLEUSI



SECCHI



BAGNO - MASTELLO



BIDONI INDUSTRIALI



MASTELLI

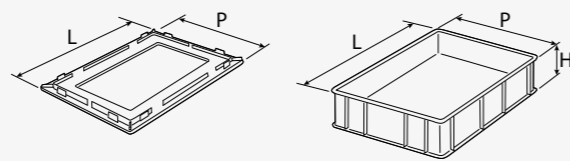

4400	L 60	P 40		
4407	L 60	P 40	H 7	l 12
4410	L 60	P 40	H 10	l 18
4413	L 60	P 40	H 13	l 24

# Cassa impilabile fondo chiuso e pareti chiuse

## Stackable crate full bottom and walls

**CONTENITORI  
PER ALIMENTI E  
MILLEUSI**  
Food and  
Multipurpose  
Containers



impilabili

-20 °C  
+80 °C

temperatura  
esercizio



**4400**  
Coperchio per casse  
*Lid for crate*



**4410**  
Cassa impilabile fondo chiuso e pareti chiuse  
*Stackable crate full bottom and walls*



Fondo liscio  
*Smooth bottom*



Fondo liscio  
*Smooth bottom*



**4407**  
Cassa impilabile fondo chiuso e pareti chiuse  
*Stackable crate full bottom and walls*



Fondo liscio  
*Smooth bottom*



**4413**  
Cassa impilabile fondo chiuso e pareti chiuse  
*Stackable crate full bottom and walls*





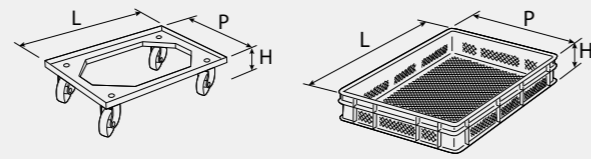

5800	L 62	P 42	H 14	
6007	L 60	P 40	H 7	l 12
6010	L 60	P 40	H 10	l 18
6013	L 60	P 40	H 13	l 24

# Cassa impilabile fondo forato e pareti forate

## Stackable crate perforated bottom and perforated walls

### CONTENITORI PER ALIMENTI E MILLEUSI

#### Food and Multipurpose Containers



impilabili

-20 °C  
+80 °C

temperatura esercizio



**5800**  
Carrello per cassetta 60x40 cm  
Trolley 60x40 cm for crate



ROB



Fondo grigliato  
Grilled bottom



**6010**  
Cassa impilabile fondo forato e pareti forate  
Stackable crate perforated bottom and perforated walls



Fondo grigliato  
Grilled bottom



**6007**  
Cassa impilabile fondo forato e pareti forate  
Stackable crate perforated bottom and perforated walls



N



Fondo grigliato  
Grilled bottom



**6013**  
Cassa impilabile fondo forato e pareti forate  
Stackable crate perforated bottom and perforated walls



N





**CONTENITORI  
PER ALIMENTI E  
MILLEUSI**  
Food and  
Multipurpose  
Containers



impilabili

-20 C°  
+80 C°

temperatura  
esercizio

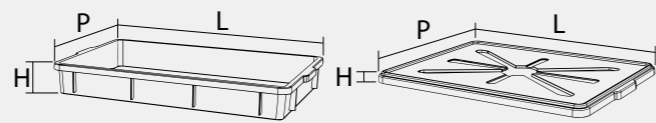

art.	L x P x H Esterne External	L x P x H Interne Internal	Capacità Capacity
5900	655 x 435 x 30	-	-
5908	650 x 425 x 85	600 x 400 x 80	19 l
5911	650 x 425 x 115	600 x 400 x 110	25 l



# Cassa LIGHT BOX

## Stackable LIGHT BOX



**5908**

Cassa chiusa impilabile con maniglie - 19 l  
Stackable crate full bottom and walls with handles - 19 l



**5911**

Cassa chiusa impilabile con maniglie - 25 l  
Stackable crate full bottom and walls with handles - 25 l



BIM



**5900**

Coperchio per casse LIGHT BOX  
Lid for LIGHT BOX crate



TS



BIM



**CONTENITORI  
PER ALIMENTI E  
MILLEUSI**  
Food and  
Multipurpose  
Containers



impilabili

-20 °C  
+80 °C

temperatura  
esercizio

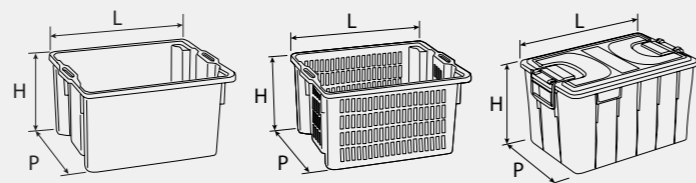

131/50	L 55 cm	P 43 cm	H 31 cm	l 50
131/65	L 63 cm	P 44 cm	H 34 cm	l 65
131/90	L 72 cm	P 47 cm	H 36 cm	l 90
132/50	L 55 cm	P 43 cm	H 31 cm	l 50
132/65	L 63 cm	P 44 cm	H 34 cm	l 65
143/20	L 38 cm	P 28 cm	H 30 cm	l 20
143/40	L 58 cm	P 38 cm	H 26 cm	l 40
143/60	L 58 cm	P 38 cm	H 38 cm	l 60

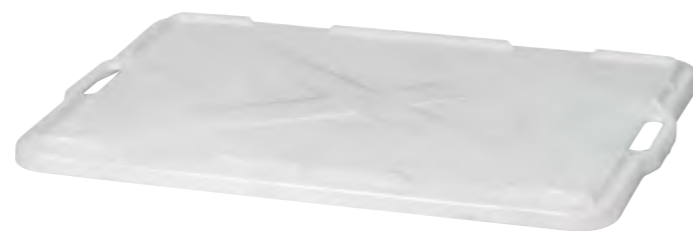

**133**  
Coperchio per cassa  
Lid for crate



**131**  
Cassa milleusi impilabile sovrapponibile  
Stackable and insertable multipurpose crates



**132**  
Cassa forata impilabile sovrapponibile  
Stackable and insertable perforated crates



**Cassa milleusi sovrapponibile ed impilabile**  
Stackable and insertable multipurpose crates



**143**  
Cassa universale con coperchio (per alimenti)  
Crate with lid (for food)



Coperchi impilabili  
Stackable lids



Porta targhetta  
Tag holder



Casse grandi e piccole tra loro  
sovrapponibili  
Large and small crates can be put  
one on the other





**CONTENITORI  
PER ALIMENTI E  
MILLEUSI**  
Food and  
Multipurpose  
Containers

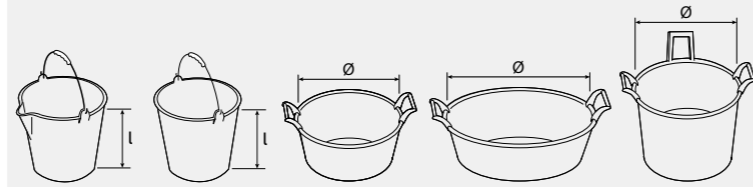

42	19	l12	l15				
39	17	l9	l12	l15			
41	Ø 32 cm	Ø 34 cm	Ø 36 cm	Ø 40 cm	Ø 45 cm	Ø 50 cm	
47	Ø 45 cm	Ø 50 cm	Ø 55 cm	Ø 60 cm	Ø 65 cm	Ø 70 cm	Ø 80 cm
82	Ø 45 cm	Ø 50 cm	Ø 55 cm	Ø 60 cm	Ø 65 cm	Ø 70 cm	



**42**  
Secchio con becco graduato  
Graduated bucket with pouring lip



**39**  
Secchio graduato  
Graduated bucket



**41**  
Bagno Tondo  
Round Basin



**47**  
Bagno ovale  
Oval basin



**art. 82**  
Mastello 3 manici  
3-handle tub







**CONTENITORI  
PER ALIMENTI E  
MILLEUSI**  
Food and  
Multipurpose  
Containers



PP 59/035



PP 59/050



PP 59/075



PP 59/100

**59**  
Coperchio dotato di maniglia  
*Lid equipped with handle*



19/035



19/050



19/075



19/100

**19**  
Bidone industriale con manici  
*Industrial bin with handles*

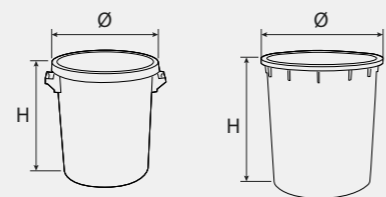

19/35	Ø 39 cm	H 41 cm	l 35
19/50	Ø 45 cm	H 47 cm	l 50
19/75	Ø 49 cm	H 57 cm	l 75
19/100	Ø 52 cm	H 67 cm	l 100
19/150	Ø 61 cm	H 70 cm	l 150
19/200	Ø 67 cm	H 80 cm	l 200
19/300	Ø 78 cm	H 88 cm	l 300

**Bidone industriale**  
Industrial bin



HD PE 59/150



HD PE 59/200



HD PE 59/300

**59**  
Coperchio  
*Lid*



19/150



19/200



19/300

**19**  
Bidone industriale senza manici  
*Industrial bin without handles*







**CONTENITORI  
PER ALIMENTI E  
MILLEUSI**  
Food and  
Multipurpose  
Containers

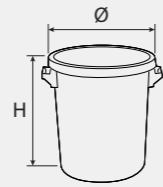

18/075	Ø 48 cm	H 57 cm	l 75
18/100	Ø 52 cm	H 67 cm	l 100



**18**

Contenitore con chiusura ad anello in metallo completo di guarnizione  
Chiusura non a tenuta stagna.

*Metal ring closure bin complete of gasket.  
Non-watertight*



# Carrello per bidone industriale

## Industrial bin trolley

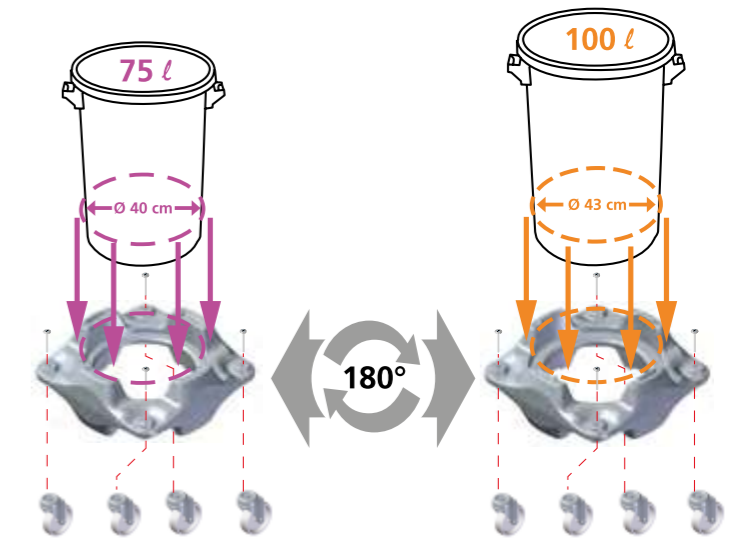

A seconda del lato in cui vengono montate le ruote è adatto al trasporto di bidoni da 75 litri o da 100 litri.

*You can fit the wheels in both sizes, one size is suitable for the 75 litres industrial bin and one for the 100 litres bin.*

Il carrello per bidone industriale ha una robusta struttura in polipropilene e 4 ruote piroettanti di cui due dotate di meccanismo di bloccaggio.

*The trolley for industrial bins is made of a solid structure in polypropylene. It has 4 turning somersault wheels, two of them have a blocking mechanism.*



Il carrello può essere impilato (anche con ruote già montate) in 2 modi diversi a seconda delle necessità.

*The trolley is stackable (you can overlap it one another even when the wheels already placed) in two different ways, as far as you need it.*



**19/1**

Carrello per bidone industriale  
Trolley for industrial bin





**CONTENITORI  
PER ALIMENTI E  
MILLEUSI**  
Food and  
Multipurpose  
Containers

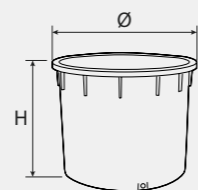

7/0110	Ø 80 cm	H 30 cm	l 110
7/0275	Ø 110 cm	H 35 cm	l 275
7/0225	Ø 86 cm	H 54 cm	l 225
7/0350	Ø 95 cm	H 71 cm	l 350
7/0500	Ø 104 cm	H 82 cm	l 500
7/0700	Ø 115 cm	H 90 cm	l 700
7/1000	Ø 134 cm	H 95 cm	l 1000

**17**

Filtro svinarola per  
rubinetto 1"

Wine filter 1" tap



**20/ 1**

Rubinetto 1"

Tap 1"



**150**

Maniglia per  
mastello

Handle for tub



# Mastelli Tub



HD PE 59/500



HD PE 59/700

**59**  
Coperchio  
Lid



7/0110



7/0275



7/0225



7/0350



7/0500



7/0700



7/1000

**7**  
Mastello  
Tub





# CONTENITORI E TRASPORTO LIQUIDI

LIQUID STORAGE AND TRANSPORT



BIDONI COLLO LARGO



FUSTINI A BOTTICELLA



TANICHE



**CONTENITORI E  
TRASPORTO LIQUIDI  
MILLEUSI**  
**LIQUID STORAGE  
AND TRANSPORT**

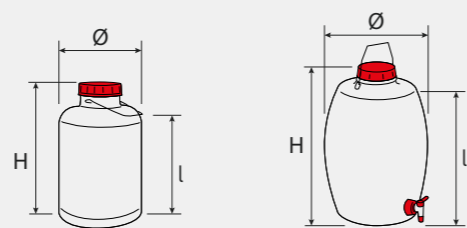

78/02	Ø 14 cm	H 21 cm	l 2	B Ø 10 cm
78/05	Ø 16 cm	H 31 cm	l 5	B Ø 10 cm
78/10	Ø 21,5 cm	H 35,5 cm	l 10	B Ø 11 cm
97/005	Ø 18 cm	H 28 cm	l 5	
97/010	Ø 23 cm	H 32 cm	l 10	
97/015	Ø 27 cm	H 37 cm	l 15	
97/020	Ø 29 cm	H 41 cm	l 20	
97/025	Ø 32 cm	H 44 cm	l 25	
97/050	Ø 39 cm	H 56 cm	l 50	
97/100	Ø 40 cm	H 71 cm	l 100	



78/02

78/05

78/10

**78**  
Bidone collo largo  
Wide neck can



# Bidone collo largo - fustino a botticella

## Wide neck can - Small barrel

**ACCESSORI  
ACCESSORIES**  
**20/1/4**  
Rubinetto 1/4"  
Tap 1/4"



particolare



97/005

97/010

97/015

97/020



97/025

97/050

97/100

**97**  
Fustino a botticella dotato di rubinetto e tappo  
Small barrel with tap and cap







# Tanica Tank

**CONTENITORI E  
TRASPORTO LIQUIDI  
MILLEUSI**  
**LIQUID STORAGE  
AND TRANSPORT**

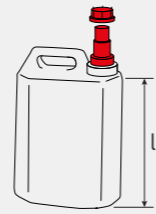

61	l 15-3,5
125/01	l 1
125/02	l 2
125/03	l 3
125/05	l 5
*125/10	l 10
*125/15	l 15
*125/20	l 20
*125/25	l 25
*125/30	l 30
73/10	l 10
73/20	l 20

## Tanica Tank



125/01    125/02    125/03    125/05



125/10    125/15    125/20    125/25    125/30



\* **Versatore telescopico incluso**  
\* **Telescopic pourer included**

## Tanica due usi Double use tank



61



## Tanica con rubinetto Tank with tap



73/10

73/20





# ACCESSORI DA CUCINA E LAVORAZIONE ALIMENTI

KITCHEN ACCESSORIES AND FOOD PROCESSING



34

BOL



35

CONTENITORI GASTRONORM



36

CARAFFE



37

IMBUTI



39

SCOLAPASTA - INSALATIERE



40

VASSOI



42

SESSOLE



43

PORTAPOSATE HORECA



**ACCESSORI DA CUCINA  
E LAVORAZIONE  
ALIMENTI**  
**KITCHEN ACCESSORIES  
AND FOOD PROCESSING**

La forma semisferica permette un'omogenea miscelazione manuale degli ingredienti. L'assenza di spigoli agevola la pulizia del prodotto.

*Its semispherical shape helps a homogeneous manual mixing of ingredients. It is easy to clean because it lacks of angles.*



Il bordo superiore, grazie alla sua particolare geometria, da rigidità a tutto il corpo della bol e funziona da "salvagoccia".

*The superior edge, thanks to its particular shape, gives rigidity to the to the body of the bowl, so that it works as "drop-saver".*



**9**  
**Bol in polipropilene**  
**Polypropylene bowl**



**96**  
**Bol in policarbonato**  
**Polycarbonate bowl**

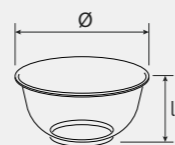

9/13	Ø 13 cm	l 0,4
9/17	Ø 17 cm	l 1,0
9/23	Ø 23 cm	l 2,5
9/28	Ø 28 cm	l 4,0
9/32	Ø 32 cm	l 8,0
9/38	Ø 38 cm	l 10,0
96/13	Ø 13 cm	l 0,4
96/17	Ø 17 cm	l 1,0
96/23	Ø 23 cm	l 2,5
96/28	Ø 28 cm	l 4,0
96/32	Ø 32 cm	l 8,0
96/38	Ø 38 cm	l 10,0

**Bol - Contenitori Gastronorm**  
**Bowl - Containers Gastronorm**

**141**  
Falso fondo GASTRONORM  
*Grilled bottom GASTRONORM*

**142**  
Contenitori GASTRONORM  
*Containers GASTRONORM*

**149**  
Coperchi GASTRONORM  
*Lids GASTRONORM*



	MOD.	COD.	SPES.	H	l		MOD.	COD.	SPES.	H	l
		142/1/1/200-PP	2,9 mm	200 mm	26,4 l			142/1/4/200-PP	2,6 mm	200 mm	4,8 l
		142/1/1/150-PP	2,8 mm	150 mm	20,0 l			142/1/4/150-PP	2,5 mm	150 mm	3,8 l
	1/1	142/1/1/100-PP	2,6 mm	100 mm	13,3 l		1/4	142/1/4/100-PP	2,3 mm	100 mm	2,6 l
		142/1/1/065-PP	2,5 mm	65 mm	9,0			142/1/4/065-PP	2,3 mm	65 mm	1,7 l
		149/1/1-PP	2,4 mm	-	-			149/1/4-PP	1,6 mm	-	-
		141/1/1-PP	2,7 mm	-	-						
		142/1/2/200-PP	2,5 mm	200 mm	11,9 l			142/1/6/200-PP	2,6 mm	200 mm	2,8 l
		142/1/2/150-PP	2,5 mm	150 mm	9,0 l			142/1/6/150-PP	2,5 mm	150 mm	2,3 l
	1/2	142/1/2/100-PP	2,5 mm	100 mm	6,1 l		1/6	142/1/6/100-PP	2,4 mm	100 mm	1,6 l
		142/1/2/065-PP	2,5 mm	65 mm	4,0 l			142/1/6/065-PP	2,3 mm	65 mm	1,0 l
		149/1/2-PP	1,75 mm	-	-			149/1/6-PP	1,4 mm	-	-
		141/1/2-PP	2,7 mm	-	-		141/1/6-PP	2,5 mm	-	-	
		142/1/3/200-PP	2,65 mm	200 mm	7,1 l			142/1/9/100-PP	1,9 mm	100 mm	0,9 l
		142/1/3/150-PP	2,6 mm	150 mm	5,5 l		1/9	142/1/9/065-PP	1,9 mm	65 mm	0,6 l
	1/3	142/1/3/100-PP	2,55 mm	100 mm	3,8 l			149/1/9-PP	1,5 mm	-	-
		142/1/3/065-PP	2,5 mm	65 mm	2,5 l						
		149/1/3-PP	1,65 mm	-	-						
		141/1/3-PP	2,5 mm	-	-						

Gli articoli in polipropilene non rientrano nella normativa Gastronorm EN 631, in quanto il naturale ritiro termico del materiale fa sì che le misure perimetrali siano fuori dalle tolleranze della normativa, anche se di soli 2-3 mm.

*The articles in polycarbonate are not included in the Gastronorm EN 631 regulations, since, according to the tolerances of the regulations, the natural thermal shrinkage of the material do not respect the external sizes, even if only of 2-3 mm.*





6/0500	10,5
6/1000	11
6/2000	12
6/3000	13
6/5000	15

# Caraffa graduata - Imbuto

## Graduated jug - Funnel

### Imbuto

#### Funnel



6/0500

6/1000

6/2000



54

Ø 6 - 8 - 10 - 12 - 14 - 16 - 18  
20 - 22 - 24 - 26 - 30 cm

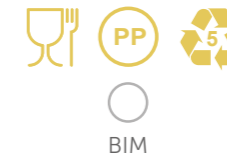

BIM



### ACCESSORI DA CUCINA E LAVORAZIONE ALIMENTI

### KITCHEN ACCESSORIES AND FOOD PROCESSING

### Caraffa graduata

#### Graduated jug



6/3000

6/5000



BIM

TS

### Imbuto con porta filtro

#### Funnel with filter-support



43

Ø 22 - 26 - 30 - 35 cm



BIM



**ART. 147/10**  
Filtro Ø 10 cm  
per imbuto Ø 22 cm  
+ Retina in acciaio inox  
Maglia 0,35 mm  
Filter Ø 10 cm  
for funnel Ø 22 cm  
+ stainless steel mesh 0,35 mm



**ART. 147/12**  
Filtro Ø 12 cm.  
per imbuto Ø 26 - 30 - 35 cm  
+ Retina in acciaio inox  
Maglia 0,35 mm  
Filter Ø 12 cm  
for funnel Ø 26 - 30 - 35 cm  
+ stainless steel mesh 0,35 mm





**ACCESSORI DA CUCINA  
E LAVORAZIONE  
ALIMENTI**  
**KITCHEN ACCESSORIES  
AND FOOD PROCESSING**

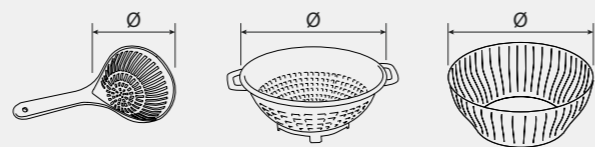

12	Ø 18 cm
109/22	Ø 22 cm
109/26	Ø 26 cm
109/30	Ø 30 cm
50/16	Ø 16 cm
50/18	Ø 18 cm
50/20	Ø 20 cm
50/22	Ø 22 cm
50/24	Ø 24 cm
50/26	Ø 26 cm
50/28	Ø 28 cm
50/30	Ø 30 cm
50/32	Ø 32 cm
50/34	Ø 34 cm



**12**  
Scolapasta con manico 39 cm  
Pasta-strainer with handle 39 cm



**109/22**

**109/26**



**109/30**

**109**  
Scolapasta  
Pasta colander



**35**  
Ø 27 cm Colalatte con filtro (Ø 10 cm)  
Ø 27 cm Milk colander with strainer (Ø 10 cm)



**10/26**  
Ø 26 cm Imbuto (PP) con tubo (PEHD) flessibile e filtro  
Ø 26 cm Funnel (PP) with flexible tube (PEHD) and filter



**50/16**

**50/18**

**50/20**

**50/22**

**50/24**

**50/26**



**50/28**

**50/30**

**50**

**50/32**

**50/34**

**50**  
Insalatiera  
Salad bowl





**130 - 128 - 134**  
Vassoi  
Trays



VASSOI con bordo 35/50/85 mm realizzati in PMMA (metacrilato antiassorbente), adatti alla presentazione di alimenti. Disponibili in 2 colori (bianco e nero) in 5 misure.

*High edge trays in PMMA 35/50/85 mm (non-absorbing methacrylate), suitable for food display. Available in 2 colours (black and white) and 5 sizes.*

ART. 130	L mm	H mm	P mm	ART. 128	L mm	H mm	P mm	ART. 134	L mm	H mm	P mm
130/A3-BIM	220	35	440	128/A3-BIM	220	50	440	134/A3-BIM	220	85	440
130/A3-NER	220	35	440	128/A3-NER	220	50	440	134/A3-NER	220	85	440
130/A4-BIM	220	35	295	128/A4-BIM	220	50	295	134/A4-BIM	220	85	295
130/A4-NER	220	35	295	128/A4-NER	220	50	295	134/A4-NER	220	85	295
130/A5-BIM	290	35	440	128/A5-BIM	290	50	440	134/A5-BIM	290	85	440
130/A5-NER	290	35	440	128/A5-NER	290	50	440	134/A5-NER	290	85	440
130/A6-BIM	220	35	220	128/A6-BIM	220	50	220	134/A6-BIM	220	85	220
130/A6-NER	220	35	220	128/A6-NER	220	50	220	134/A6-NER	220	85	220
130/A7-BIM	220	35	360	128/A7-BIM	220	50	360	134/A7-BIM	220	85	360
130/A7-NER	220	35	360	128/A7-NER	220	50	360	134/A7-NER	220	85	360

## ACCESSORI DA CUCINA E LAVORAZIONE ALIMENTI KITCHEN ACCESSORIES AND FOOD PROCESSING

VASSOI con bordo basso realizzati in SAN (antiassorbente), adatti alla presentazione di alimenti. Disponibili in 2 colori (bianco e nero) in 5 misure.

*Low edge trays in SAN (anti-absorbent), suitable for food display. Available in 2 colours (black and white) and 5 sizes.*



**148**  
Vassoi  
Trays

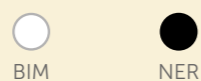

ART. 148	L mm	H mm	P mm
148/20-BIM	200	12	150
148/20-NER	200	12	150
148/28-BIM	280	12	190
148/28-NER	280	12	190
148/35-BIM	350	12	240
148/35-NER	350	12	240
148/42-BIM	420	12	300
148/42-NER	420	12	300
148/50-BIM	500	12	360
148/50-NER	500	12	360

### Esempi abbinamenti per 130 - 128 - 134

Con i vassoi della nuova linea a bordo alto (35 - 50 - 85 mm), oltre ad avere un maggior spessore, si possono realizzare abbinamenti tra le varie misure e altezze (vedi disegni con alcune possibilità).

*The brand new range of display trays, high sided (35 - 50 - 85 mm) and thicker, thanks to their new dimensions allow to suit a standard surface by different displays and heights (see examples below).*

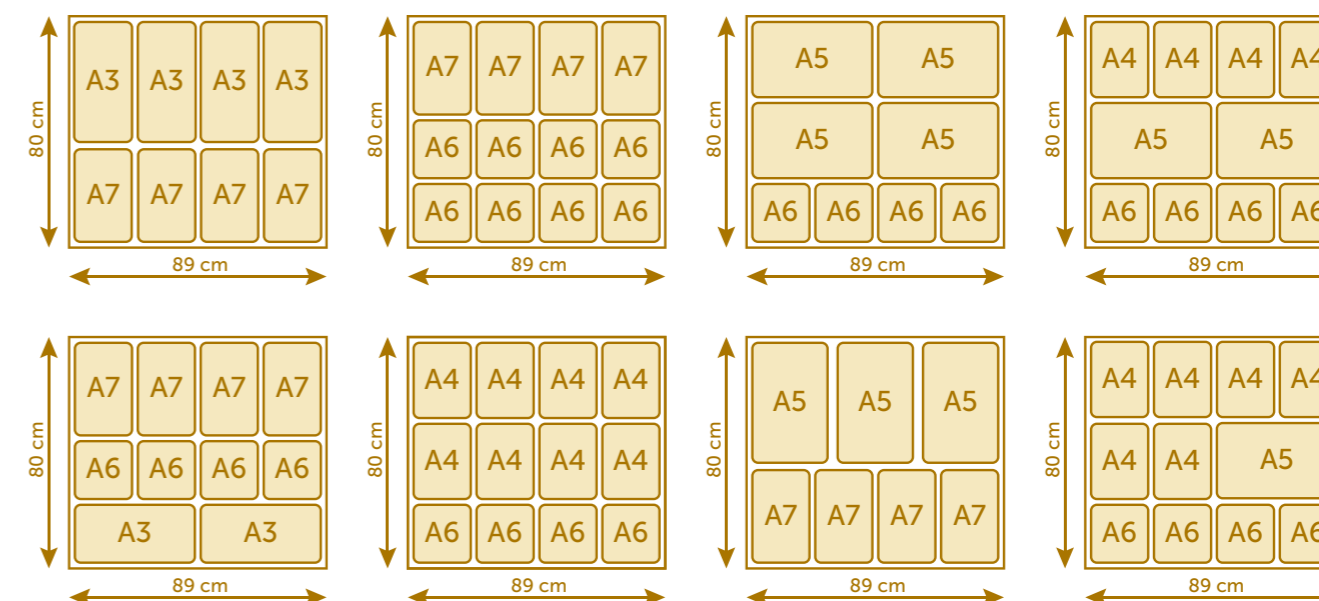





**ACCESSORI DA CUCINA  
E LAVORAZIONE  
ALIMENTI**  
**KITCHEN ACCESSORIES  
AND FOOD PROCESSING**

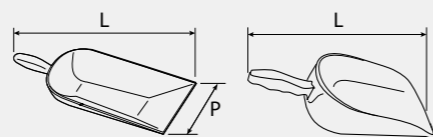

	L	P	l
31	43 cm	15 cm	-
136/19	19 cm	-	0,1
136/24	24 cm	-	0,2
136/29	29 cm	-	0,3
136/34	34 cm	-	0,6
136/38	38 cm	-	0,9
136/42	42 cm	-	1,5

**SESSOLA RETTANGOLARE  
RECTANGULAR LARGE-SPOON**



**31**  
Sessola rettangolare  
Rectangular large-spoon

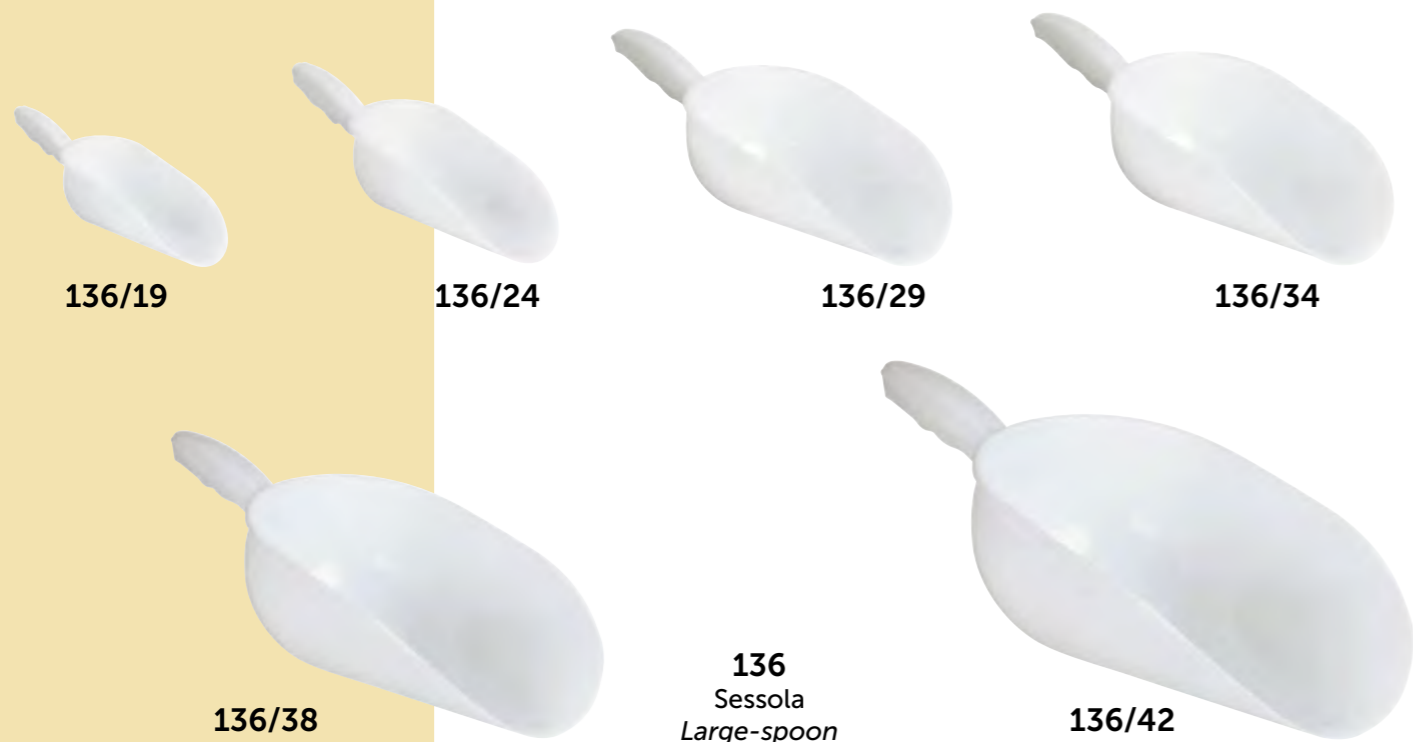

136/19

136/24

136/29

136/34

136/38

**136**  
Sessola  
Large-spoon

136/42



BIM

# Sessole - Portaposate HORECA

## Large-spoon - HORECA cutlery tray

Le linee morbide e senza spigoli vivi delle capienti vasche facilitano la presa delle posate e le operazioni di pulizia. Le dimensioni del PORTAPOSATE HORECA (53x32,5xh9,5 cm) rispettano le misure GASTRONORM 1/1.

*The smooth lines without corners and the wide depth of the compartments make it easier to clean and help to remove the cutlery from it. The dimensions of the HORECA CUTLERY TRAY (53x32,5xh9,5 cm) are those required by the GASTRONORM 1/1.*



Il COPERCHIO, grazie alle sue particolari concavità corrispondenti alle vasche del portaposate, permette la sovrapposibilità dei portaposate chiusi e può essere usato da basamento quando non svolge la sua funzione di copertura.

*The LID, thanks to its particular concave compartments of the cutlery containers, can be piled up when they are closed, so that they can be used as a flat base whether they do not work as to close the cutlery tray.*



**Portaposate HORECA**  
**HORECA cutlery tray**



Le lunette, incavate lateralmente nel bordo superiore, servono come invito alla presa e da fessura per il sollevamento del PORTAPOSATE nel caso che quest' ultimo sia incassato dentro ad una apertura da banco GASTRONORM.

The lunette, hollowed in the upper edge, work as handles and help the taking out of the cutlery tray. They are especially useful to remove the cutlery tray when it is set in an open glass of the food display.

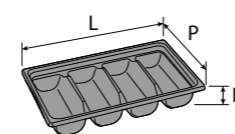

L 32,5 X P 53 X H 9,5 cm



**86**  
Portaposate HORECA  
HORECA cutlery tray

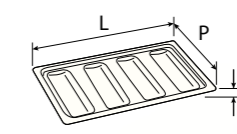

L 32,5 X P 53 X H 2 cm



**86/1**  
Coperchio per portaposate HORECA  
HORECA cutlery tray lid



GRI



TS





# PULIZIA & RACCOLTA DIFFERENZIATA

CLEANING & WASTE COLLECTION



BIDONI CARRELLATI 120 l



BIDONI CARRELLATI 240 l



SERRATURA GRAVITAZIONALI



BIDONE 100 PUSH



BIDONE DUSTY



BIDONE NELLO



BIDONI CARRELLATI 360 l



CASSONETTI 4 RUOTE 660 l



CASSONETTI 4 RUOTE 770 l



BIDONE 91



BIDONE INDUSTRIALE 35-200 l

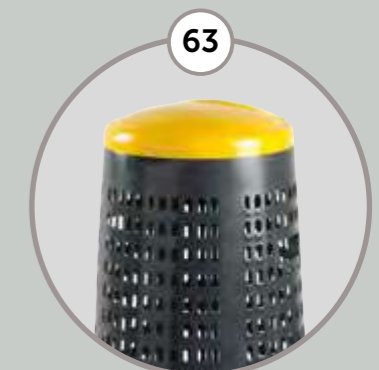

TREPOLO



CASSONETTI 4 RUOTE 1100 l



BIDONE 80



BIDONE 100



ECO-AIR



PORTARIFIUTI ECOLOGY



PULIZIA

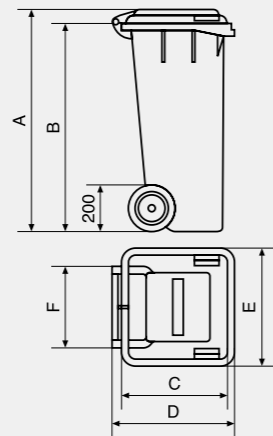

Carrellato	120 litri
A	930 mm
B	875 mm
C	485 mm
D	550 mm
E	480 mm
F	355 mm
G	480 mm
PESO / WEIGHT	9 Kg

**PULIZIA & RACCOLTA  
DIFFERENZIATA**  
CLEANING &  
WASTE COLLECTION

Bidone carrellato 120 litri a due ruote per la raccolta differenziata. Prodotto realizzato in HDPE (polietilene alta densità) 100% riciclabile, stabilizzato UV per utilizzo in ambienti esterni. Capacità di carico max 60 kg. Predisposto per presa frontale a pettine a norma DIN. Dotato di due ruote in gomma diametro 200 mm. Grande maneggevolezza, maniglie ergonomiche, bordi e spigoli arrotondati. Coperchio con apertura a libro e bordo anti infiltrazione, sede per alloggiamento microchip, elevata resistenza meccanica ed agli agenti chimici, facile da pulire e sanificare. Disponibile in 8 colori. Versione bicolore con bidone di colore grigio e coperchi in 4 colori differenti.

*Two-wheeled 120 liter mobile waste bin for differential refuse collection. Product made of 100% recyclable HDPE (high density polyethylene), UV stabilized for outdoor use. Max load capacity 60 kg. Prepared for DIN standard frontal socket. Equipped with two 200 mm diameter rubber wheels. Easy handling, ergonomic handles, rounded corners and edges. Lid with book opening and anti-infiltration edge, seat for microchip housing, high mechanical and chemical resistance, easy to clean and sanitize. Available in 8 colors. Bicolor available with grey body and lid in 4 different colors.*



UNI EN 840  
Certificato  
Certified



1/120/5  
120 litri



# Bidoni carrellati e Bidoni carrellati bicolore

120 l

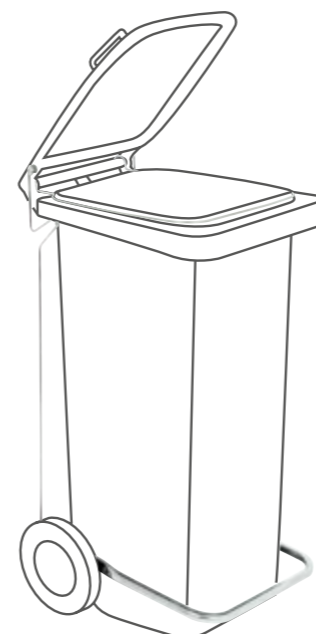

1204

Kit pedale + anello per bidone 120 l  
120 l bin pedal and ring



1/120

Anello fermasacco per bidone 120 l  
120 l bin ring



95/120

Sacchetti immondizia per bidone  
raccolta differenziata 120 l  
120 l bin liners bags



1/120

Anello fermasacco per bidone bicolore 120 l  
120 l bin ring



1/120/5  
120 litri



- BIANCO LATTE (BIL)
- GIALLO (GIA)
- VERDE SCURO (VES)
- VERDE BIDONE (VEB)
- BRUNO BIDONE (BRB)
- BLU BIDONE (BLB)
- ROSSO BIDONE (ROB)
- GRIGIO BIDONE (GRB)

- GRIGIO-GIALLO (GRB-GIA)
- GRIGIO-VERDE (GRB-VES)
- GRIGIO-BLU (GRB-BLB)
- GRIGIO-ROSSO (GRB-ROB)



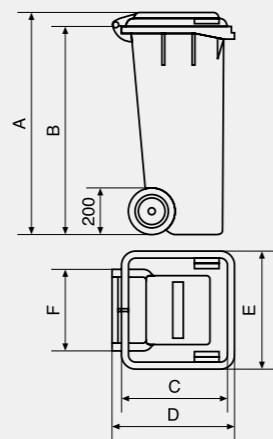

Carrellato	240 litri
A	1070 mm
B	995 mm
C	655 mm
D	730 mm
E	580 mm
F	420 mm
G	570 mm
PESO / WEIGHT	13 Kg

**PULIZIA & RACCOLTA  
DIFFERENZIATA**  
CLEANING &  
WASTE COLLECTION



**Bidone carrellato 240 litri a due ruote per la raccolta differenziata.**  
Prodotto realizzato in HDPE (polietilene alta densità) 100% riciclabile, stabilizzato UV per utilizzo in ambienti esterni. Capacità di carico max 60 kg. Predisposto per presa frontale a pettine a norma DIN. Dotato di due ruote in gomma diametro 200 mm. Grande maneggevolezza, maniglie ergonomiche, bordi e spigoli arrotondati. Coperchio con apertura a libro e bordo anti infiltrazione, sede per alloggiamento microchip, elevata resistenza meccanica ed agli agenti chimici, facile da pulire e sanificare.  
Disponibile in 8 colori.  
Versione bicolore con bidone di colore grigio e coperchi in 4 colori differenti.

*Two-wheeled 240 liter mobile waste bin for differential refuse collection. Product made of 100% recyclable HDPE (high density polyethylene), UV stabilized for outdoor use. Max load capacity 60 kg. Prepared for DIN standard frontal socket. Equipped with two 200 mm diameter rubber wheels. Easy handling, ergonomic handles, rounded corners and edges. Lid with book opening and anti-infiltration edge, seat for microchip housing, high mechanical and chemical resistance, easy to clean and sanitize. Available in 8 colors. Bicolor available with grey body and lid in 4 different colors.*



UNI EN 840  
Certificato  
Certified



1/240/5  
240 litri



# Bidoni carrellati e Bidoni carrellati bicolore

240 l

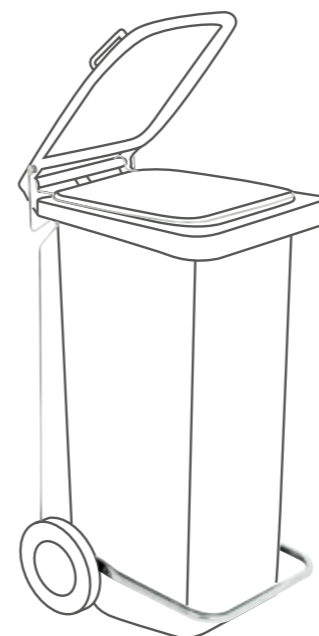

2404

Kit pedale + anello per bidone 240 l  
240 l bin pedal and ring



1/240

Anello fermasacco per bidone 240 l  
240 l bin ring



95/ 240

Sacchetti immondizia per bidone  
raccolta differenziata 240 l  
240 l bin liners bags



1/240

Anello fermasacco per bidone bicolore 240 l  
240 l bin ring



1/240/5  
240 litri





# SERRATURA GRAVITAZIONALE per bidoni carrellati 120/240 l

Il sistema a serratura gravitazionale consente allo stesso tempo:

- l'apertura e la chiusura del coperchio del bidone solamente al possessore della chiave;
- lo svuotamento del bidone da parte degli addetti alla raccolta dei rifiuti anche con serratura chiusa in quanto l'apertura del contenitore avviene in automatico una volta raggiunta una certa inclinazione (>90°) in fase di svuotamento e la chiusura viene ripristinata una volta che il contenitore viene riportato in posizione.

Il sistema rende inoltre possibile aprire il bidone dall'interno anche con serratura chiusa (per situazioni di emergenza) e non consente l'apertura accidentale del bidone in caso di rovesciamento, urti e/o atti di vandalismo.

Il kit è formato da:

- un cupolotto con serratura integrata da montare esternamente sul coperchio;
- un elemento con gancio da collocare sulla parte interna del coperchio;
- un corpo inferiore da installare nella parte interna della vasca;
- due chiavi per aprire/chiedere la serratura;
- le dime per individuare la posizione dei fori e consentire il montaggio del sistema.

The gravitational lock system allows at the same time:

- the opening and closing of the lid of the bin only to the holder of the key;
- the emptying of the bin by the waste collectors even with the lock closed as the opening of the container takes place automatically once a certain inclination (>90°) is reached during the emptying phase and the closure is restored once the container is returned to position.

The system also makes it possible to open the bin from the inside even with the lock closed (for emergency situations) and does not allow accidental opening of the bin in case of overturning, collisions and / or vandalism.

The kit consists of:

- a dome with integrated lock to be mounted externally on the lid;
- an element with a hook to be placed on the inside of the lid;
- a lower body to be installed in the internal part of the tank;
- two keys to open / close the lock;
- the templates to identify the position of the holes to allow to assemble the kit on the bin.



1/111



PULIZIA & RACCOLTA DIFFERENZIATA  
CLEANING & WASTE COLLECTION



# Bidoni carrellati

360 l

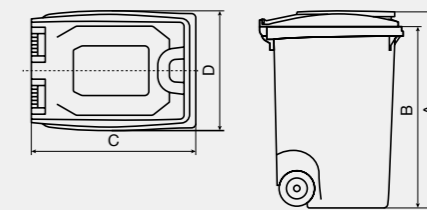

A	1105
B	1010
C	875
D	635
PESO / WEIGHT	15,4 Kg

## Bidone carrellato 360 litri a due ruote per la raccolta differenziata.

Prodotto realizzato in HDPE (polietilene alta densità) 100% riciclabile, stabilizzato UV per utilizzo in ambienti esterni. Capacità di carico max 160 kg Predisposto per presa frontale a pettine a norma DIN. Dotato di due ruote in gomma diametro 200 mm alloggiabili in due distinte posizioni per un'agile movimentazione e stabilità. Grande maneggevolezza, maniglie ergonomiche, bordi e spigoli arrotondati. Coperchio con apertura a libro e bordo anti infiltrazione, sede per alloggiamento microchip, elevata resistenza meccanica ed agli agenti chimici, facile da pulire e sanificare. Disponibile in 5 colori.

Versione bicolore con bidone di colore grigio e coperchi in 4 colori differenti.

## Two-wheeled 360 liter mobile waste bin for differential refuse collection.

Product made of 100% recyclable HDPE (high density polyethylene), UV stabilized for outdoor use. Max load capacity 160 kg. Prepared for DIN standard frontal socket. Equipped with two 200 mm diameter rubber wheels that can be housed in two distinct positions to move the bin in an easy way and have great stability. Easy handling, ergonomic handles, rounded corners and edges. Lid with book opening and anti-infiltration edge, seat for microchip housing, high mechanical and chemical resistance, easy to clean and sanitize. Available in 5 colors.

Bicolor available with grey body and lid in 4 different colors.



1/360/5  
360 litri



- GRIGIO BIDONE (GRB)
- GIALLO (GIA)
- VERDE BIDONE (VEB)
- ROSSO BIDONE (ROB)
- BLU BIDONE (BLB)
- GRIGIO-GIALLO (GRB-GIA)
- GRIGIO-ROSSO (GRB-ROB)
- GRIGIO-VERDE (GRB-VEB)
- GRIGIO-BLU (GRB-BLB)



# Cassonetti 4 ruote 660 l

**PULIZIA & RACCOLTA  
DIFFERENZIATA**  
CLEANING &  
WASTE COLLECTION



**Cassonetto carrellato 4 ruote capacità 660 litri con coperchio piano.**  
Prodotto realizzato in HDPE (polietilene alta densità) 100% riciclabile stabilizzato UV per utilizzo in ambienti esterni.  
Capacità di carico max 310 kg. Predisposto per presa frontale a pettine a norma DIN, dotato di quattro ruote girevoli (due delle quali con freno) con battistrada in gomma diametro 200. Grande maneggevolezza, assenza di bordi taglienti e spigoli smussati. Dotato di maniglie ergonomiche per la movimentazione, tappo sul fondo per una corretta pulizia e sanificazione. Coperchio piano con apertura a libro ed impugnatura a labbro e bordo anti infiltrazione, sede per alloggiamento microchip.  
Elevata resistenza meccanica ed agli agenti chimici.  
Disponibile in 4 colori.  
Disponibile versione bicolor con vasca di colore grigio e coperchi in 3 colori differenti.

*Four-wheeled 660 liter mobile waste bin for differential refuse collection with flat lid. Product made of 100% recyclable HDPE (high density polyethylene), UV stabilized for outdoor use. Max load capacity 310 kg. Prepared for DIN standard frontal socket, equipped with four 200 mm diameter rubber caster wheels (two of them with braking system).*

*Easy handling, ergonomic handles, rounded corners and edges. Equipped with ergonomic handles for handling, cap on the bottom for proper cleaning and sanitization. Flat lid with book opening and lip handle and anti-infiltration edge, seat for microchip housing. High mechanical and chemical resistance.*

*Available in 4 colors.  
Bicolor available with grey body and lid in 3 different colors.*



**6604**

Kit pedale per cassonetto 660 l  
660 l bin pedal



**1/660/5**  
660 litri



● GRIGIO BIDONE (GRB) ● GIALLO (GIA) ● VERDE BIDONE (VEB) ● BLU BIDONE (BLB) ● GRIGIO-GIALLO (GRB-GIA) ● GRIGIO-VERDE (GRB-VEB) ● GRIGIO-BLU (GRB-BLB)

# Cassonetti 4 ruote 770 l

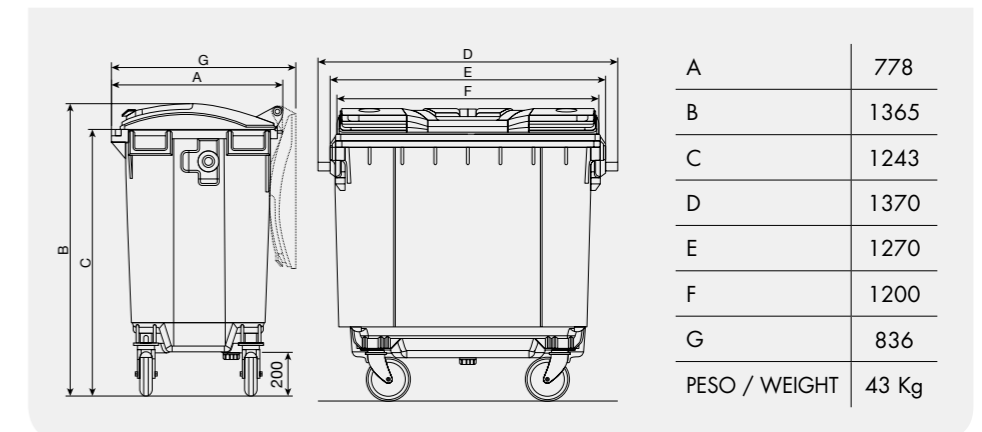

**Cassonetto carrellato 4 ruote capacità 770 litri con coperchio piano.**  
Prodotto realizzato in HDPE (polietilene alta densità) 100% riciclabile stabilizzato UV per utilizzo in ambienti esterni.  
Capacità di carico max 360 kg. Predisposto per presa frontale a pettine a norma DIN, dotato di quattro ruote girevoli (due delle quali con freno) con battistrada in gomma diametro 200. Grande maneggevolezza, assenza di bordi taglienti e spigoli smussati. Dotato di maniglie ergonomiche per la movimentazione, tappo sul fondo per una corretta pulizia e sanificazione. Coperchio piano con apertura a libro ed impugnatura a labbro e bordo anti infiltrazione.  
Elevata resistenza meccanica ed agli agenti chimici.  
Disponibile in 4 colori.  
Disponibile versione bicolor con vasca di colore grigio e coperchi in 3 colori differenti.

*Four-wheeled 770 liter mobile waste bin for differential refuse collection with flat lid. Product made of 100% recyclable HDPE (high density polyethylene), UV stabilized for outdoor use. Max load capacity 360 kg. Prepared for DIN standard frontal socket, equipped with four 200 mm diameter rubber caster wheels (two of them with braking system).*

*Easy handling, ergonomic handles, rounded corners and edges. Equipped with ergonomic handles for handling, cap on the bottom for proper cleaning and sanitization. Flat lid with book opening and lip handle and anti-infiltration edge, seat for microchip housing. High mechanical and chemical resistance.*

*Available in 4 colors.  
Bicolor available with grey body and lid in 3 different colors.*



**7704**

Kit pedale per cassonetto 770 l  
770 l bin pedal



**1/770/5**  
770 litri



● GRIGIO BIDONE (GRB) ● GIALLO (GIA) ● VERDE BIDONE (VEB) ● BLU BIDONE (BLB) ● GRIGIO-GIALLO (GRB-GIA) ● GRIGIO-VERDE (GRB-VEB) ● GRIGIO-BLU (GRB-BLB)





# Cassonetti 4 ruote 1100 l

**PULIZIA & RACCOLTA  
DIFFERENZIATA**  
CLEANING &  
WASTE COLLECTION

**TÜV Rheinland**  
UNI EN 840  
Certificato  
Certified



1/1100/5  
660 litri



GRIGIO BIDONE (GRB) GIALLO (GIA) VERDE BIDONE (VEB) BLU BIDONE (BLB) GRIGIO-GIALLO (GRB-GIA) GRIGIO-VERDE (GRB-VEB) GRIGIO-BLU (GRB-BLB)

# Bidone 80 80 l

**Bidoni per la raccolta differenziata da 80 l**  
particolarmente adatti per utilizzo interno in tutti gli ambienti. Disponibile in 4 colori (giallo, verde, rosso e blu) con base grigia.

**Waste Bin 80 l**  
Wheelie bins suitable for internal use in all locations (offices, industries, communities...) Available in 4 colors (yellow, green, red and blue) with grey base.

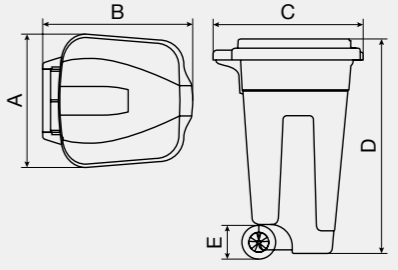

80	80 litri
A	450 mm
B	500 mm
C	500 mm
D	780 mm
E	120 mm
PESO / WEIGHT	3 Kg

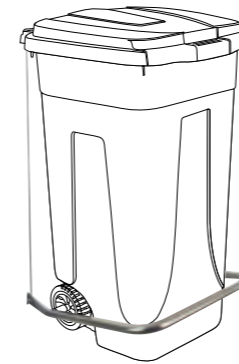

**804**  
Kit pedale  
Pedal kit



**95/80**  
Sacchetti immondizia per bidone raccolta differenziata 80 l  
80 l bin liners bags

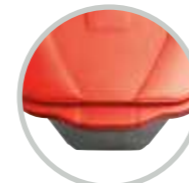

Coperchi con chiusura a clip  
Clip down lid



Maniglia ergonomica e rinforzata per facilitarne il trasporto  
Ergonomic and thicker handle for an easy handling



Dotato di 4 ganci fermasacco  
With 4 hooks keep bag



Bidone facilmente impilabile con ruote montate  
Easy stackable bins with preassembled wheels



Alta scorrevolezza delle ruote antiscivolo ed estrema maneggevolezza nello spostamento  
No-slip wheels and easy to manoeuvre



Ruote e assali premontati, meno errori e più facilità di spedizione con bloccaggio delle ruote per l'utilizzo finale  
Wheels and axles already assembled, fast delivery and less problems. Wheels with brake for final use



80  
80 litri



GRIGIO-GIALLO (GRB-GIA) GRIGIO-ROSSO (GRB-ROB) GRIGIO-VERDE (GRB-VEB) GRIGIO-BLU (GRB-BLB) BIANCO (BIL)

**plastica**  
seconda vita  
MIX ECO  
Tranne BIANCO (BIL) - Except for WHITE (BIL)





# Bidone 100

100 l

# 100 PUSH

100 l

## PULIZIA & RACCOLTA DIFFERENZIATA

## CLEANING & WASTE COLLECTION



Coperchi con chiusura a clip  
Clip down lid

Maniglia ergonomica e rinforzata per facilitarne il trasporto  
Ergonomic and thicker handle for an easy handling



Dotato di 4 ganci fermasacco  
With 4 hooks keep bag



Bidone facilmente impilabile con ruote montate  
Easy stackable bins with preassembled wheels



Alta scorrevolezza delle ruote antiscivolo ed estrema maneggevolezza nello spostamento  
No-slip wheels and easy to manoeuvre



Ruote e assali premontati, meno errori e più facilità di spedizione con bloccaggio delle ruote per l'utilizzo finale  
Wheels and axles already assembled, fast delivery and less problems. Wheels with brake for final use



100  
100 litri



GRIGIO-GIALLO (GRB-GIA) GRIGIO-ROSSO (GRB-ROB) GRIGIO-VERDE (GRB-VEB) GRIGIO-BLU (GRB-BLB)

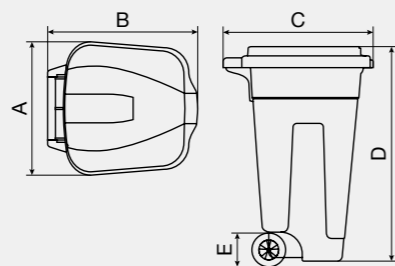

100	100 litri
A	490 mm
B	540 mm
C	540 mm
D	850 mm
E	143 mm
PESO / WEIGHT	3,70 Kg

Bidoni per la raccolta differenziata da 100 l particolarmente adatti per utilizzo interno in tutti gli ambienti. Disponibile in 4 colori (giallo, verde, rosso e blu) con base grigia.

**Waste Bin 100 l** Wheelie bins suitable for internal use in all locations (offices, industries, communities...) Available in 4 colors (yellow, green, red and blue) with grey base.



95/1  
Sacchetti immondizia per bidone raccolta differenziata 100 l  
100 l bin liners bags

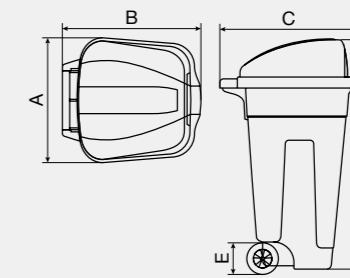

100 PUSH	100 litri
A	490 mm
B	540 mm
C	540 mm
D	950 mm
E	143 mm
PESO / WEIGHT	3,70 Kg

Bidoni per la raccolta differenziata da 100 l particolarmente adatti per utilizzo interno in tutti gli ambienti. Disponibile in 4 colori (giallo, verde, rosso e blu) con base grigia.

**Waste Bin 100 l** Wheelie bins suitable for internal use in all locations (offices, industries, communities...) Available in 4 colors (yellow, green, red and blue) with grey base.



95/1  
Sacchetti immondizia per bidone raccolta differenziata 100 l  
100 l bin liners bags



Campana basculante per bidone Cento Push  
Flap lid for bin Cento Push



Maniglia ergonomica e rinforzata per facilitarne il trasporto  
Ergonomic and thicker handle for an easy handling



Dotato di 4 ganci fermasacco  
With 4 hooks keep bag



Bidone facilmente impilabile con ruote montate  
Easy stackable bins with preassembled wheels



Alta scorrevolezza delle ruote antiscivolo ed estrema maneggevolezza nello spostamento  
No-slip wheels and easy to manoeuvre



Ruote e assali premontati, meno errori e più facilità di spedizione con bloccaggio delle ruote per l'utilizzo finale  
Wheels and axles already assembled, fast delivery and less problems. Wheels with brake for final use



100 PUSH  
100 litri



GRIGIO-GIALLO (GRB-GIA) GRIGIO-ROSSO (GRB-ROB) GRIGIO-VERDE (GRB-VEB) GRIGIO-BLU (GRB-BLB)



# Bidone DUSTY

## 25 l

DUSTY	25 litri
A	400 mm
B	360 mm
C	450 mm
PESO / WEIGHT	0,95 Kg

**Pratico bidone portarifiuti da 25 litri,** con coperchio dotato di chiusura a clip. Realizzato in polipropilene (PP) riciclabile 100%. Design moderno, si adatta a tutti gli ambienti. Disponibile con bidone di colore grigio e 4 varianti di colore per il coperchio utili per la raccolta differenziata.

*Practical 25 liter waste bin, with lid equipped with clip closures. Made of 100% recyclable polypropylene (PP). Modern design, adapts to all environments. Available with grey bin and 4 color variations for the lid useful for recycling.*



**plastica**  
seconda vita  
MIX ECO

105/25  
25 litri



- GRIGIO-GIALLO (GRB-GIA)
- GRIGIO-ROSSO (GRB-ROB)
- GRIGIO-VERDE (GRB-VEB)
- GRIGIO-BLU (GRB-BLB)

# Bidone NELLO

**Nello** è un bidone di nuova concezione che si distingue innanzitutto per il felice connubio estetico-funzionale evidenziato da linee morbide e ben raccordate tra loro. Dotato di ruote e comoda maniglia per spostamenti veloci e sicuri, pedale di apertura e anello reggisacco. Si adatta agli ambienti di lavoro professionale e hobbistico, come officine, garage, laboratori industriali.

**151-GRN** completo di n. 8 tappi in 4 colori per una corretta identificazione della differenziata.

*Nello is a new-concept bin, which combines beauty and functionality stressed by an elegant and harmonic design. Equipped with wheels and a handle for fast and safe movings, an opening pedal and bags holder ring.*

*It is suitable for internal use in all locations (workshops, garages, studios).*

*151-GRN includes a set of nr 8 cups in 4 different colours for a right waste separation and identification.*

NELLO	80 litri
A	650 mm
B	810 mm
C	400 mm
PESO / WEIGHT	6,20 Kg



Fornito in kit d'assemblaggio  
Supplied in assembly kit

**plastica**  
seconda vita  
MIX ECO



151  
80 litri



- GRIGIO BIDONE (GRN)
- BIANCO (BIL)



95/ 80  
Sacchetti immondizia per bidone NELLO 80 l  
Bin liners for NELLO 80 l



Apertura a pedale  
Opening pedal



**PULIZIA & RACCOLTA  
DIFFERENZIATA**  
**CLEANING &  
WASTE COLLECTION**



**95/1**

Sacchetti immondizia  
per bidone con cerniera.  
*Bin liners for hinged bin.*



**91/060**  
60 litri

# Bidone 91

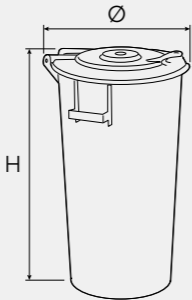

art. 91	Ø	H	capacità
91/060	Ø 45 cm	H 60 cm	60 l
91/080	Ø 45 cm	H 74 cm	80 l
91/100	Ø 45 cm	H 88 cm	100 l

**Bidone con coperchio**  
Bin with hinged lid



**91/080**  
80 litri



**91/100**  
100 litri



●  
NERO  
(NER)

# Bidone INDUSTRIALE da 35 a 200 l



**art. 8**  
Bidone industriale.  
Industrial bin.

**art. 77**  
Coperchi da l 35 a l 100 in PP  
Coperchi da l 150 a l 200 in HDPE  
*Lids from 35 to 100 litres made of PP*  
*Lids from 150 to 200 litres made of HDPE*

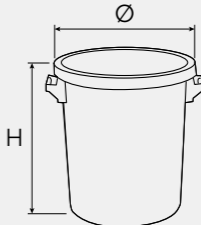

Bidoni industriali	litri	H	Ø
8/0035	35 l	41 cm	39 cm
8/0050	50 l	47 cm	46 cm
8/0075	75 l	57 cm	48 cm
8/0100	100 l	67 cm	52 cm
8/0150	150 l	71 cm	62 cm
8/0200	200 l	81 cm	67 cm



**8/0035**



PP 77/035



**8/0050**



PP 77/050



**8/0075**



PP 77/075



**8/0100**



PP 77/100



**8/0150**



77/150



●  
NERO  
(NER)



**8/0200**



77/200





**PULIZIA & RACCOLTA  
DIFFERENZIATA**  
**CLEANING &  
WASTE COLLECTION**

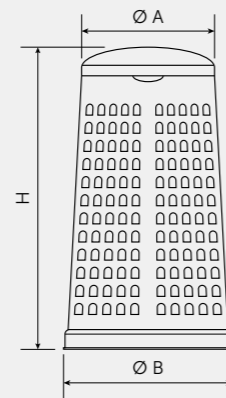

Treapolo	Ø A	Ø B	H	l
69/110	380 cm	510 cm	850 cm	110

Treapolo leggero e facilmente sollevabile.  
Pratico e semplice da utilizzare.  
Lavabile e sterilizzabile.  
Estremamente versatile per ogni tipo di rifiuto perchè prevede l'utilizzo del sacco raccogli immondizia, che viene fissato tramite l'anello ferma-sacco.  
Ecologico, costruito in polietilene alta densità 100 % riciclabile.  
Impilabile, occupa poco spazio in altezza.  
È facilmente impilabile anche con il coperchio montato.

*Lightweight and easily liftable mesh waste bin.  
Practical and easy to use.  
Washable and sterilizable.  
Suitable for each kind of waste, bag tie to ensure the bin bag stays secure.  
Ecological, made of 100 % recyclable PEHD.  
Stackable, it takes up little space in height.  
Easily stackable also with preassembled lid.*



**plastica**  
seconda vita  
MIX ECO

**TRESPOLO**  
110 l



**95/1**  
Sacchetti immondizia  
per trespolo portasacco 110 l  
110 l Bin liners for trestle.



Possibilità di inserire loghi personalizzati  
Customized logo available



69/110



GRIGIO  
(GRB)

VERDE  
(VES)

GRIGIO-GIALLO  
(GRB-GIA)

GRIGIO-VERDE  
(GRB-VES)

GRIGIO-BLU  
(GRB-BLB)

GRIGIO-ROSSO  
(GRB-ROB)





# ECO-AIR 4

# Portarifiuti ECOLOGY

25/35 l

**PULIZIA & RACCOLTA  
DIFFERENZIATA**  
**CLEANING &  
WASTE COLLECTION**

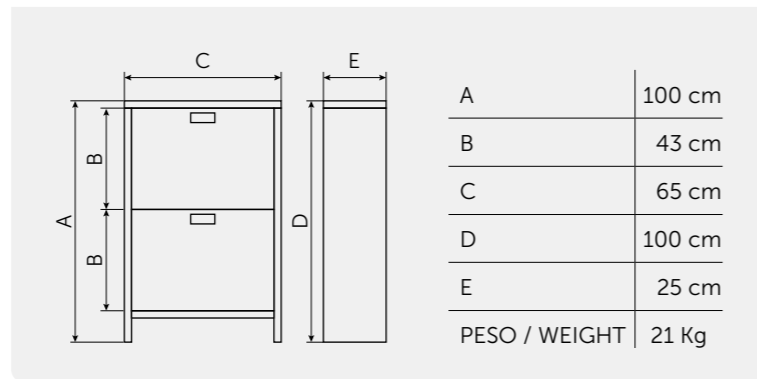

### Mobiletto ventilato in lamiera elettrosaldata verniciato a forno in polvere epossidica

a due ribalte sovrapposte contenenti due secchi da 20 l ognuna. A - Aerazione, ventilazione: il mobiletto è dotato di griglie di aerazione che hanno lo scopo di favorire la fermentazione dei residui organici e di smaltire l'odore sgradevole.

B - Robusti piedi, sollevato da terra per una agevole pulizia.

### Cabinet in electro welded plate painted by epoxy powder oven.

with two superposed tilt drawers including two 20 l buckets each. A - Airing/ ventilation: the cabinet is equipped with grates that help fermentation of the organic refusal and discharge the unpleasant odours.

B - Strong feet, lifted base to allow an easy cleaning.

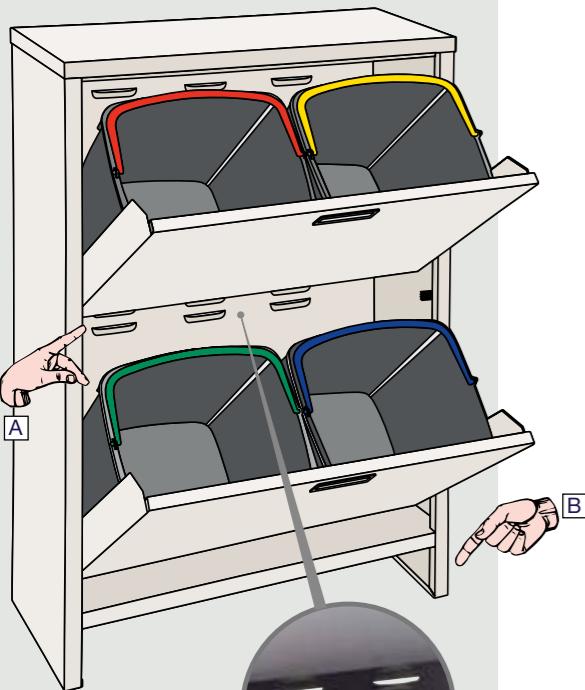

Aerazione,  
ventilazione  
Airing, ventilation



**KIT 100/4-MIX**  
Ordinabile anche separatamente  
To be ordered also separately

**100/4-GR**  
Completo di 4 secchi  
Complete with 4 buckets



Pratico e robusto contenitore portarifiuti, ideale per la raccolta differenziata urbana e domestica si adatta a tutti gli ambienti per il suo design moderno e funzionale, dotato di sportello basculante a becco e coperchio con meccanismo antirandagismo e comodo maniglione ergonomico con blocco verticale. Realizzato in compound di Polipropilene (PP) riciclabile al 100%, resistente agli agenti atmosferici, chimici ai raggi UV per utilizzo intensivo all'esterno. Totale assenza di spigoli, superfici lisce per una agevole pulizia e sanificazione, impilabile e inseribile, predisposizione per RFDI, presa sul fondo per un facile svuotamento, coperchio con cerniere rinforzate per una apertura a 270°. Disponibile nelle misure da 25 lt e 35 lt., con contenitore e coperchio di colore Grigio e con sportello e maniglione di presa in 4 varianti di colore.

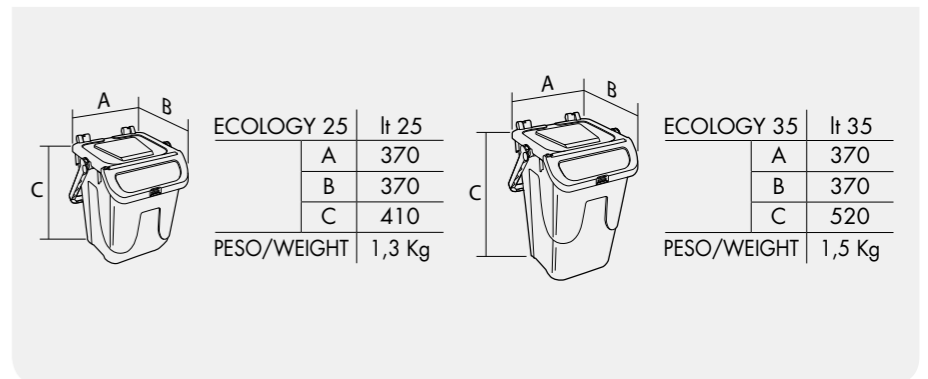

Sturdy and functional waste bin, ideal for urban and domestic use. Its stylish and functional design makes it perfect for all environments. This bin is provided with a hinged and anti stray lid, ergonomic handle with vertical locking. The bin is made from polypropylene compound, 100% recyclable, weather, chemical and UV resistant allowing it to be safely used outside. No edges, smooth surfaces, easy to clean and disinfect, stackable and nestable, RFID technology predisposed. Reinforced hinges to allow a 270° opening, easy emptying system thanks to ergonomic grips on the bottom. Available sizes 25 and 35 l, grey bin with flap and handle in 4 colors.



Impilabile e inseribile. Presa sul fondo per un facile svuotamento, coperchio con cerniere rinforzate per una apertura a 270°. Dotato di sportello basculante a becco e coperchio con meccanismo antirandagismo e maniglione con blocco verticale. Stackable and nestable.

Easy emptying system thanks to ergonomic grips on the bottom, reinforced hinges to allow a 270° opening. Provided with a hinged and anti stray lid, ergonomic handle with vertical locking.



**plastica**  
seconda vita  
MIX ECO



● GRIGIO-GIALLO (GRB-GIA) ● GRIGIO-BRUNO (GRB-BRB) ● GRIGIO-VERDE (GRB-VES) ● GRIGIO-BLU (GRB-BLB)

● RAL 7035



**PULIZIA & RACCOLTA  
DIFFERENZIATA**  
CLEANING &  
WASTE COLLECTION

# PULIZIA

**Cestino gettacarta**  
Waste-paper basket

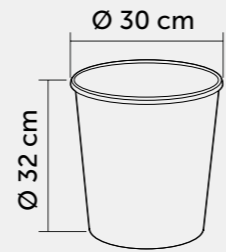

● GRIGIO  
(GRI)

● 107/30  
NERO  
(NER)

● BRUNO BIDONE  
(BRR)

**Alzaimmondizia con manico**  
Standing dustpan

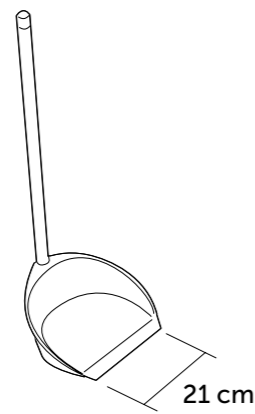

● BRUNO BIDONE  
(BRR)

90



**Paletta polvere**  
Dustpan

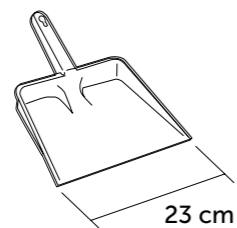

● BRUNO BIDONE  
(BRR)

124/23



# Legenda / Legend



TUTTI GLI ARTICOLI CONTRASSEGNA TI DAL SIMBOLO ALIMENTARE, SONO CONFORMI  
ALLE DIRETTIVE CE n. 1935/2004, 2023/2006 E 10/2011  
ALL ITEMS MARKED WITH THE FOOD USE LOGO, MEET EC REG.  
n. 1935/2004, 2023/2006 AND 10/2011

MATERIALE / MATERIAL

Ⓟ : polipropilene / polypropylene

ⓂⓅ : polietilene ad alta densità / high density polyethylene

ⓁⓅ : polietilene a bassa densità / low density polyethylene

ⓂⓈ : acrilonitrile-butadiene-stirene / acrylonitrile-butadiene-styrene

ⓈⓂ : SAN (antiassorbente) / SAN (non-absorbing)

ⓂⓂⓂ : PMMA metacrilato antiassorbente / PMMA non-absorbing methacrylate

Ⓟ : Policarbonato / Polycarbonate

COLORI / COLOURS

○ BIL: = bianco latte / milky white

○ BIM: = bianco / white

● BLB: = blu bidone / bin blue

● BRB: = bruno bidone / bin brown

● BRR: = bruno rame / copper brown

● GIA: = giallo / yellow

● GRB-GIA: = grigio-giallo / grey-yellow

● GRB-VEB: = grigio-verde chiaro / grey-light green

● GRB-VES: = grigio-verde / grey-green

● GRB-BLB: = grigio-blu / grey-blue

● GRB-ROB: = grigio-rosso / grey-red

● GRA: = grigio antracite / anthracite grey

● GRB: = grigio bidone / bin grey

● GRI: = grigio / grey

● GRN: = grigio nero / black grey

● N: = neutro / neutral

● NER: = nero / black

● ROB: = rosso bidone / bin-red

○ TS: = bianco trasparente / transparent white

● VEB: = verde chiaro / light green

● VES: = verde scuro / dark green







# SERVIZIO CLIENTI

## Customer service

• MOBIL PLASTIC offre un completo servizio di informazioni attraverso il suo Ufficio Commerciale e Marketing. Un contatto diretto, per informazioni e richieste di cataloghi, si può avere anche attraverso la e-mail [info@mobilplastic.it](mailto:info@mobilplastic.it) e l'accesso al sito Internet [www.mobilplastic.it](http://www.mobilplastic.it)

• MOBIL PLASTIC offers a complete information service by means of the Sales and Marketing Department. You can contact the company directly for information and catalogues by e-mail [info@mobilplastic.it](mailto:info@mobilplastic.it) and Internet Web site [www.mobilplastic.it](http://www.mobilplastic.it)

servizio  
clienti



Tel. 0039 0384 674692



servizio  
clienti

Fax. 0039 0384 674696

e-mail

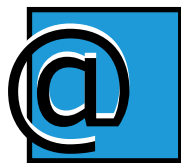

[info@mobilplastic.it](mailto:info@mobilplastic.it)



internet

[www.mobilplastic.it](http://www.mobilplastic.it)

## Informazioni / Inquiries

I colori riprodotti hanno valore indicativo.

The reproduced colours have an indicative value.

Le misure indicate hanno una tolleranza di  $\pm 2$  mm.

The above-cited dimensions have a tolerance of  $\pm 2$  mm.

I colori ed i modelli potranno subire variazioni senza preavviso.

Colours and models can be subject to change without warning.

È possibile fornire per quantità e prezzi da stabilire: prodotti in colori fuori catalogo; prodotti in materiale autoestinguente a norma UL 94; prodotti personalizzati.

It is possible to supply the following in individually arranged quantities and prices: Goods in colours not in catalogue; Goods in self extinguishing materials conforming to the norms UL 94; Personalized products.

Per impieghi diversi da quelli tradizionali si suggerisce di chiedere esplicite indicazioni.

For specific and different uses other than those listed it is suggested to contact the company directly.