



Cerutti Inox

CATALOGO PROFESSIONALE 2024





Cerutti Inox

Professionalmente inimitabili

WWW.CERUTTINOX.IT



La Nostra Storia



Cerutti Inox è stata fondata nel 1960 da Serafino Cerutti ed è gestita oggi dalle due generazioni successive. Fin dalla sua fondazione l'azienda ha costantemente aumentato le sue dimensioni, di pari passo con la gamma di prodotti.

Cerutti Inox è specializzata nella lavorazione della lamiera utilizzando le tecnologie e le attrezzature più all'avanguardia che consentono un ciclo industriale su larga scala partendo dalla lamiera per concludere con il prodotto finito, destinato principalmente al settore alberghiero. I prodotti Cerutti raggiungono un alto livello di qualità ed eccellenza tecnica grazie all'impegno e all'alta professionalità delle risorse umane. Negli ultimi anni, l'azienda è riuscita a sviluppare una presenza estremamente interessante e dinamica, derivante positivamente dal suo background tecnico/tecnologico. I suoi punti di forza sono la **flessibilità di struttura e produzione e l'affidabilità del prodotto**. Oltre alla produzione di articoli a proprio marchio, Cerutti Inox sviluppa particolari su richiesta del cliente, occupandosi dell'industrializzazione fino alla realizzazione e imballaggio.

La sede legale della Società è situata a Crusinallo di Omegna, nella provincia del Verbano-Cusio-Ossola, a metà strada tra i laghi Orta e Maggiore, mentre il centro amministrativo e operativo si trova a Cuzzago di Premosello Chiovenda, a pochi chilometri dal confine svizzero, adiacente il Parco Nazionale della Val Grande e si estende in un'area di oltre 12000 metri quadrati.

Nel 2004, Cerutti Inox ha ottenuto la **certificazione ambientale e di qualità**, nel 2006 è stata la prima azienda certificata per il **Marchio del Distretto del VCO** (Verbano-Cusio-Ossola) e nel 2018 ha ottenuto la **certificazione Moca per i prodotti destinati al contatto con gli alimenti**. L'azienda si avvale della preziosa collaborazione di professionisti di talento che hanno portato un'onda di stile e originalità alla nuova linea di prodotti.



750
PALA PIZZERIA "CAPRICCIO"
SHOVEL FOR PIZZA-SHOP
cm 35 x 190



Our Story



Cerutti Inox was founded in 1960 by Serafino Cerutti and is run today by the successive generations. Since its foundation, the company has constantly increased in size, hand in hand with the range of products.

Cerutti Inox specializes in **metal sheet working processes** and uses the most avant-garde technologies and equipment for a full-scale industrial cycle, from the sheet of steel to the finished products, mostly intended for **hospitality industry**. Cerutti's products reach a high level of quality and technical excellence thanks to the commitment and high professionalism of its human resources. In the last few years, the firm has succeeded in developing an extremely interesting and dynamic presence, as a positive result of its technical/technological background. Strong points are both the **structure and production flexibility** and the **product reliability**. As well as the manufacture of own products, Cerutti Inox develops and produces commissioned objects and particulars in other materials.

The Company's legal headquarters are situated in Crusinallo di Omegna, in the province of Verbano-Cusio Ossola (VCO), half way between Lakes Orta and Maggiore, whilst the administrative and operative centre is in Cuzzago di Premosello Chiovenda, a few kilometres from Swiss border, next to the Val Grande National Park. The establishment is situated in an area of over 12000 square metres. In 2004, Cerutti Inox gained **Environmental and Quality Certifications**, in 2006 it was the first company certified for **Household District of VCO Mark** and in 2018 obtained **MOCA certification** (materials and objects intended to come into contact with food). The company has benefited from the precious collaboration of confirmedly talented professionals who have brought a wave of style and originality to the new line of products.



1980 Pala Acciaio Inox

È il 1980 quando viene realizzata, la prima pala pizza dalle forme semplici in acciaio inox. Questa pala trova un notevole successo, ispirando quindi il successivo studio e implementazione del prodotto.

It was 1980 when the first pizza shovel with simple shapes in stainless steel was made. This shovel found considerable success, thus inspiring the subsequent study and implementation of the product.



1993 Pala CAPRICCIO

È il 1993 quando viene realizzata, la prima pala pizza chiamata "Capriccio", in acciaio inox e manico in alluminio.

It was 1993 when the first pizza shovel called "Capriccio" was made, in stainless steel and aluminum handle.



2017 Pala TULIP

Nel 2017 nasce Tulip, una linea di pale la cui forma a "coda di delfino" è stata disegnata dall'architetto Itamar Harari ed il cui nome è stato ispirato dal primo prototipo realizzato nella versione tonda che ha ricordato il fiore del tulipano.

Tulip was born in 2017, a line of pizza shovels, whose "dolphin tail" shape was designed by the architect Itamar Harari and whose name was inspired by the first prototype made in the round version that recalled the tulip flower.



2020 Pala 60° ANNIVERSARIO

Nel 2020 Cerutti Inox, in occasione del 60° anno di attività, realizza una nuova pala, sempre in collaborazione con l'architetto Itamar Harari. Con eleganti forature a spiga, e l'inconfondibile qualità. Novità presentata nel 2021.

In 2020 Cerutti Inox, on the occasion of the 60th year of activity, creates a new shovel, again in collaboration with the architect Itamar Harari. With elegant wheat spike shaped perforations, and the unmistakable quality. New product presented in 2021.



2022 Pala Anodizzata Dura

Introduzione della nuova linea Anodizzata Dura che garantisce un altissimo grado di resistenza, durata e maggior semplicità di utilizzo.



The company presented the new range of Hard Anodized Shovels that guarantee a very high resistance, durability and greater ease of use.

**SCEGLI
LA
QUALITÀ**



Cerutti Inox

Certificazioni Certifications

-  Nel 2004, Cerutti Inox ha ottenuto la certificazione ambientale e di qualità, mentre nel 2018 ha ottenuto la certificazione Moca per i prodotti destinati al contatto con gli alimenti, ed il Rating di legalità.
-  In 2004, Cerutti Inox gained Environmental and Quality certification, and in 2018 obtained MOCA certification (materials and object intended to come into contact with food), and the legality Rating.





Tecnologia Technology





-  Con un'attenzione continua verso le nuove tecnologie e gli investimenti, Cerutti Inox realizza i propri prodotti utilizzando macchinari e procedure sempre all'avanguardia che gli consentono una grande flessibilità, permettendogli di incontrare le esigenze dei propri clienti.
-  With constant attention to new technologies and investments, Cerutti Inox manufactures its products using cutting-edge machinery and procedures that allow us to have great flexibility and meet the needs of our customers.

Qualità Quality

-  Grazie al proprio know-how, ai processi di lavorazione svolti quasi interamente al proprio interno e alla professionalità e impegno delle proprie risorse umane, i prodotti Cerutti Inox sono riconosciuti nel mondo per il loro grado di qualità e affidabilità.
-  Thanks to its know-how, the manufacturing processes carried out almost entirely in-house and the professionalism and commitment of its human resources, Cerutti Inox products are recognized worldwide for their degree of quality and reliability.





Servizio Service

-  Cerutti Inox mette a disposizione della sua clientela una rete vendita distribuita su tutto il territorio nazionale e Internazionale, garantendo un servizio costante e veloce, volto a soddisfare ogni esigenza.
-  Cerutti Inox offers its customers a sales network distributed throughout the national and international territory, guaranteeing a constant and fast service, aimed at satisfying every need.



Collaborazioni Collaborations



-  Da anni Cerutti Inox collabora con **NIP Food, La Nazionale Italiana Pizzaioli**, che durante i suoi corsi di formazione ed eventi utilizza le pale e gli accessori Cerutti Inox per formare professionalmente tanti nuovi pizzaioli Italiani.
-  Cerutti Inox has been collaborating for years with NIP Food, the Italian National Pizza Makers Academy, which during its training courses and events, uses Cerutti Inox shovels and accessories to professionally train most of the new Italian pizza makers.

-  Laureato in architettura a Firenze nel 1989. Trasferitosi a Milano, inizia una serie di collaborazioni con importanti studi. È titolare di uno studio di progettazione che spazia tra architettura, interni e, in particolare, design, collaborando con aziende come: Foscarini, Valli&Valli, Prealpi, Brandoni, Visentin, Rapsel, Carmenta, Sanelli, Gedy, Luxo. Tiene conferenze al Politecnico e all'Accademie di Belle Arti di Brera a Milano, di Ascola e Tel Aviv e di Bezalel a Gerusalemme ed inoltre collabora con numerose riviste di settore.

-  Graduated in Architecture from Florence University in 1989. After moving to Milan, he began collaborating with important studios. He now has his own design studio whose activities embrace architecture, interior decoration and, in particular, design in collaboration with firms like Foscarini, Valli&Valli, Prealpi, Brandoni, Visentin, Rapsel, Carmenta, Sanelli, Gedy, Luxo. He has lectured at Milan Polytechnic, and the Academies of Fine Arts of Brera, Milan, Ascola in Tel Aviv and Bezalel in Jerusalem as well as contributing to numerous specialist journals.

Designer Designer



ITAMAR HARARI

 Una community che raccoglie professionisti della ristorazione e pizzeria, nonchè appassionati e amatori che si avvicinano con curiosità a questo mondo.

 A community that gathers restaurant and pizzeria professionals, as well as enthusiasts and amateurs who approach this world with curiosity.

SOCIAL

Tratta dal contest **King of Pizza**
From contest **King of Pizza**



cerutti_inox
 Piace a grafos_gws e altri cerutti_inox Settimana scorsa ti abbiamo annunciato che ad @hostmilano avremo un ospite speciale. Ecco qui un piccolo spoiler: l'hai riconosciuto? Nel prossimo post scopri insieme a noi tutti i dettagli!



COMMUNITY

In collaborazione con **Pizzaioli di tutto il mondo**
In collaboration with **Pizza chefs from all over the world**



 Tutte le novità dal mondo della cucina professionale, trend e fiere nel mondo.

 All the news from the world of professional cooking, trends and exhibitions around the world.

Seguici Follow us



@ceruttinox.it @cerutti_inox Cerutti Inox Srl @ceruttinoxrsl

Indice

Index



ACCESSORI PIZZERIA Pizza Accessories

TEGLIE DA FORNO Baking trays

PALE PIZZA Pizza Shovels

Pale per brace e cenere	pag.60
Spazzole	pag. 61/69
Porta pale	pag. 71/72
- Cucchiai	pag.73
Olierone	pag.73
- Palette, spatole	pag.74
- Forbici	pag.74
- Rotelle	pag.75
- Retine	pag.75
- Casette pizza	pag.76
- Accessori pizzeria	pag.76
Accessori delivery...pag.77/80	
- Valigetta professionale	pag.77
- Zaino termico	pag.78
Accessori delivery Pol600	
.....	pag. 79
Accessori delivery Nylon	
.....	pag.80

SETACCI Sieves

Setacci	pag.83/89
- Asciugapasta	pag.85
- Setacci Farina	pag.86
- Setacci Pane	pag.87
- Setacci Pesce	pag.88
- Setacci Pasticceria	pag.89

Teglie	pag.91/97
Lamiera blu	pag.93/94
Alluminate	pag.95
Alluminio	pag.96/97

Pale "Tulip"	pag.14/15
- Quadre	pag.16/17
- Tonde	pag.18/19
- Rettangolari	pag.20/21
Pale "Tulip 60"	pag.23
- Quadre	pag.24
- Tonde	pag.25
Pale "Tulip GF"	pag.27
- Quadre	pag.28/29
- Tonde	pag.30/31
- Rettangolari	pag.32/33
- 60° GF	pag.34/35
Pale Anodizzate dure	pag.36/40
Pale "Smart"	pag.43/46
Pale pizza al metro..pag.47/48	
Pale a sfornare INOX	pag. 49/55
KIT	pag.56
Espositore	pag.57

Indice

Index



ACCESSORI RISTORAZIONE *Catering accessories*

- Accessori ristorazione..... pag.99/107**
- Accessori tavola e cucina pag.100/103
 - Porta tacospag. 102
 - Coppe Macedoniapag. 104
 - Formaggierepag. 104
 - Accessori pasticceriapag.105
 - Set condimentipag.106/107

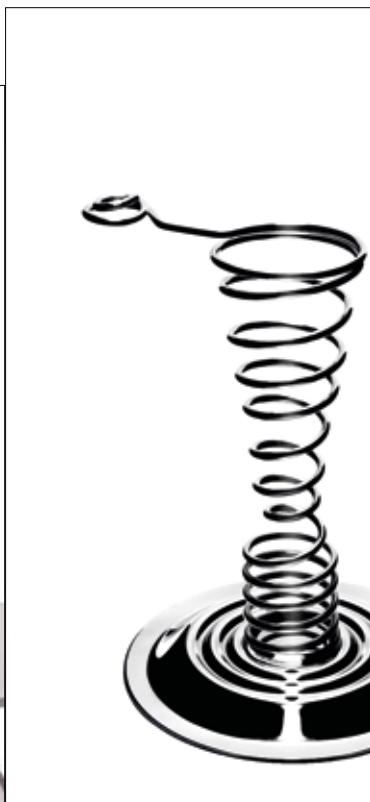

ACCESSORI GELATERIA *Ice cream shops accessories*

- Accessori gelateria pag.109/111**
- Serviconopag.110
 - Spatole gelatopag.111
 - Piatto cassatapag.111

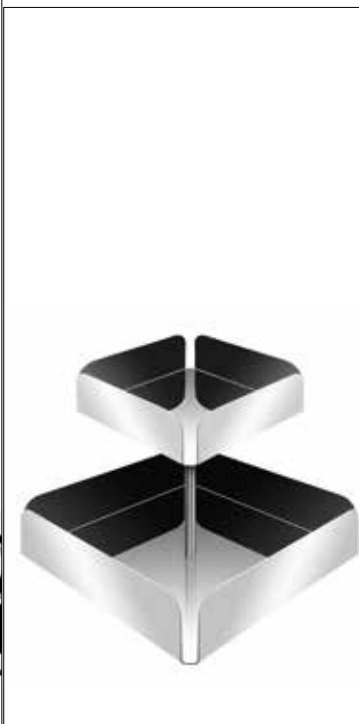

PORTATOVAGLIOLI *Napkin holders*

- Portatovaglioli pag.114**
- Porta bustinepag.115



COLONNINE PORTA GEL *Columns for gel*

- Colonnina portagel..... pag.117/118**
- Colonnina portagel c/supporto pag. 118
 - Colonnina portagel c/supporto e mensolapag. 118



Pale pizza

Pizza shovels:

- Pale Linea TULIP
Shovels range TULIP
- Pale Linea TULIP
60° Anniversario
Shovels range TULIP 60° Anniversario
- Pale Linea TULIP GF
Shovels range TULIP GF
- Pale Anodizzate dure
Shovels hard anodizing
- Pale Linea Smart
Shovels range Smart
- Pale pizza al metro
Shovels by the meter
- Pale a sfornare inox
Turning peels

Pale TULIP designed by Itamar Harari

Realizzata in lega di alluminio anodizzato, la sua particolare ed inconfondibile forma a “coda di delfino” è stata disegnata dall’architetto Itamar Harari, sempre molto attento nell’eleganza dei particolari, mentre il suo nome è stato ispirato dal primo prototipo realizzato nella versione tonda che ha ricordato il fiore del tulipano. Non solo design ma anche qualità, la particolare nervatura della pala Tulip le dona stabilità e resistenza all’uso intensivo. Promossa dalla Nazionale Italiana Pizzaioli, in brevissimo tempo è stata apprezzata dai più grandi professionisti del mondo.

Tulip

MADE IN ITALY

FRESATURA FRONTALE

La speciale fresatura, crea la perfetta aderenza fra pala e piano di lavoro, permettendo un’ottimale presa in carico della pizza.

The special milling creates perfect adherence between the shovel and the worktop, allowing an optimal sliding of the pizza.



NERVATURA

Questa speciale nervatura regala grande **stabilità** lasciando il giusto spazio all’impasto.

This special rib gives great stability, leaving the right space for the dough.



RIVETTI

Utilizzati per garantire **robustezza e sicurezza** fra il manico e la testa della pala.

Used to ensure strength and safety between the handle and the head of the shovel.



COLORE MANICO: Rosso
HANDLE COLOR: Red

L'**anodizzazione** dell'alluminio è un processo elettrochimico che applica una patina di ossido artificiale sulla lega metallica. Tecnicamente, l'ossido ricopre la superficie dell'alluminio dandogli maggiore resistenza nei confronti degli agenti atmosferici, dell'abrasione e una maggiore omogeneità della finitura.

Aluminum anodizing is an electrochemical process that applies an artificial oxide patina to the metal alloy. Technically, the oxide covers the surface of the aluminum giving it greater resistance to atmospheric agents, abrasion and greater homogeneity of the finish.

MADE IN ITALY

Pizza Shovel TULIP

🇬🇧 Made of anodized aluminum alloy, its particular and unmistakable “dolphin tail” shape was designed by the architect Itamar Harari, always very attentive in the elegance of details, while its name was inspired by the first prototype made in the round version that reminded of the tulip flower. Not only design but also quality, the particular rib of the Tulip shovel gives it stability and resistance to intensive use. Promoted by the Italian National Pizza Makers, in a very short time it was appreciated by the greatest professionals in the world.

MANICO SMONTABILE Detachable handle



CODICE	DESCRIZIONE
MS2	alluminio / aluminum

🇮🇹 Il sistema **click lock**, applicabile a qualsiasi modello di pala con manico in alluminio, permette di avere un manico smontabile ma con la rigidità e resistenza proprie del manico unico, questo è possibile grazie alla lavorazione di precisione delle parti che lo compongono.

Questo manico smontabile è applicabile a tutte le pale.

🇬🇧 The **click lock** system, applicable to any model of shovel with aluminum handle, allows to have a removable handle but with the rigidity and resistance of the single handle, this is possible thanks to the precision machining of the parts that compose it. **This detachable handle is applicable to all shovels.**

Come ordinarlo? Aggiungendo al codice della pala desiderata il riferimento MS2 (es. 752F33E+MS2)

How to order? Add the reference MS2 to the code of the desired shovel (ex: 752F33E+MS2)

GANCIO APPENDIBILE Hangable hook

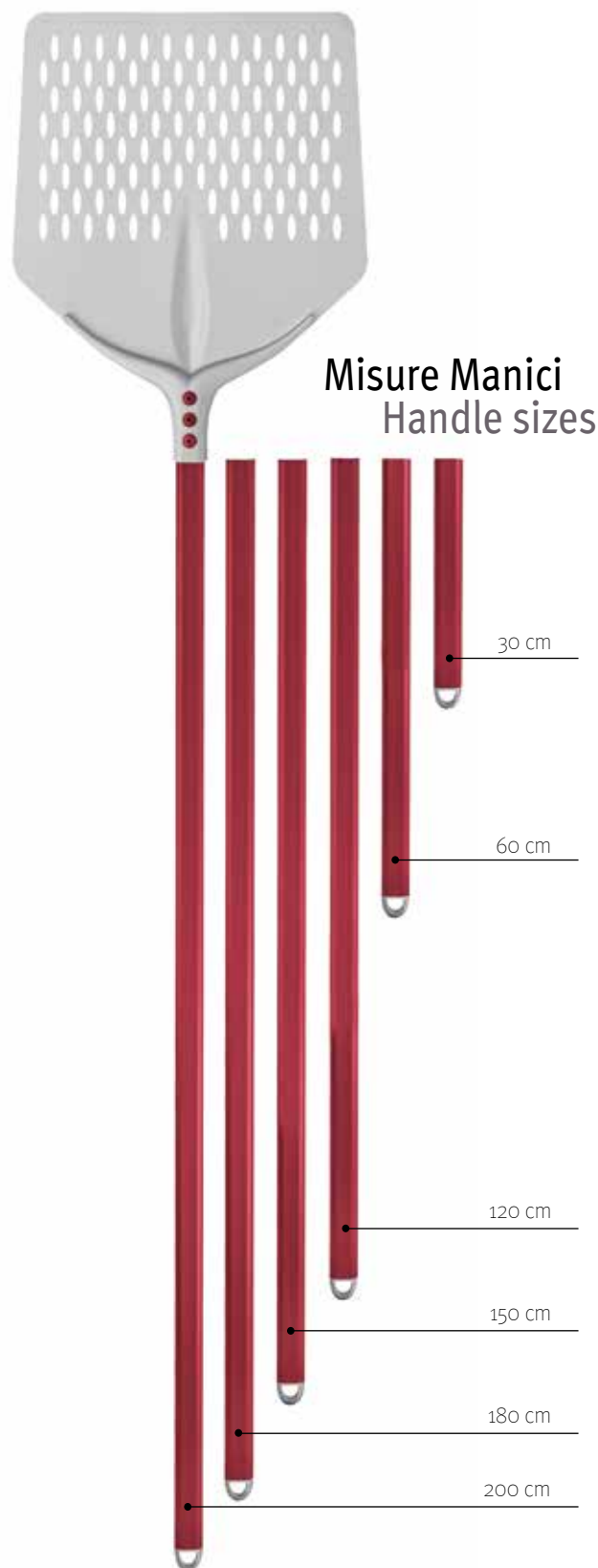





Pale quadre

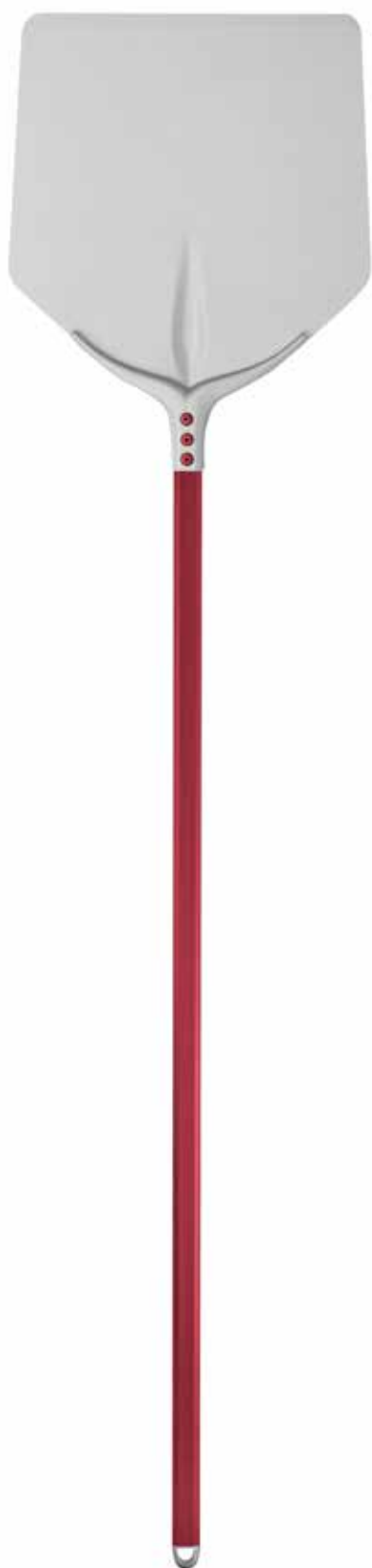

Cod. 752

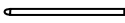

Pala quadra in alluminio anodizzato
Square pizza shovel in anodized aluminum



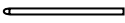

CODICE	EAN		
752/33 E	8014130233704	30 cm	33x33 cm
752/33 D	8014130233698	60 cm	33x33 cm
752/33	8014130232080	120 cm	33x33 cm
752/33 A	8014130232547	150 cm	33x33 cm
752/33 B	8014130240030	180 cm	33x33 cm
752/33 C	8014130244618	200 cm	33x33 cm

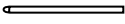
CODICE	EAN		
752/36 E	8014130241198	30 cm	36x36 cm
752/36 D	8014130240016	60 cm	36x36 cm
752/36	8014130231502	120 cm	36x36 cm
752/36 A	8014130231007	150 cm	36x36 cm
752/36 B	8014130242294	180 cm	36x36 cm
752/36 C	8014130244632	200 cm	36x36 cm

CODICE	EAN		
752/41 E	8014130242096	30 cm	41x41 cm
752/41 D	8014130244397	60 cm	41x41 cm
752/41	8014130232103	120 cm	41x41 cm
752/41 A	8014130233346	150 cm	41x41 cm
752/41 B	8014130242317	180 cm	41x41 cm
752/41 C	8014130244656	200 cm	41x41 cm



CODICE	EAN		
752/45 E	8014130244274	30 cm	45x45 cm
752/45 D	8014130244410	60 cm	45x45 cm
752/45	8014130232127	120 cm	45x45 cm
752/45 A	8014130231700	150 cm	45x45 cm
752/45 B	8014130241211	180 cm	45x45 cm
752/45 C	8014130244670	200 cm	45x45 cm



CODICE	EAN		
752/50 D	8014130251678	60 cm	50x50 cm
752/50	8014130242270	120 cm	50x50 cm
752/50 A	8014130251616	150 cm	50x50 cm
752/50 B	8014130251630	180 cm	50x50 cm
752/50 C	8014130251654	200 cm	50x50 cm



Pale quadre forate

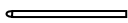

Cod. 752F



Pala quadra forata in alluminio anodizzato
Perforated square pizza shovel in anodized aluminum

CODICE	EAN		
752F33 E	8014130240092	30 cm	33x33 cm
752F33 D	8014130233674	60 cm	33x33 cm
752F33	8014130232141	120 cm	33x33 cm
752F33 A	8014130232387	150 cm	33x33 cm
752F33 B	8014130233568	180 cm	33x33 cm
752F33 C	8014130241631	200 cm	33x33 cm

CODICE	EAN		
752F36 E	8014130244090	30 cm	36x36 cm
752F36 D	8014130240931	60 cm	36x36 cm
752F36	8014130232165	120 cm	36x36 cm
752F36 A	8014130231731	150 cm	36x36 cm
752F36 B	8014130233582	180 cm	36x36 cm
752F36 C	8014130244694	200 cm	36x36 cm

CODICE	EAN		
752F41 E	8014130244311	30 cm	41x41 cm
752F41 D	8014130244298	60 cm	41x41 cm
752F41	8014130232189	120 cm	41x41 cm
752F41 A	8014130232509	150 cm	41x41 cm
752F41 B	8014130242331	180 cm	41x41 cm
752F41 C	8014130244717	200 cm	41x41 cm

CODICE	EAN		
752F45 E	8014130244335	30 cm	45x45 cm
752F45 D	8014130243338	60 cm	45x45 cm
752F45	8014130232202	120 cm	45x45 cm
752F45 A	8014130232424	150 cm	45x45 cm
752F45 B	8014130240139	180 cm	45x45 cm
752F45 C	8014130241235	200 cm	45x45 cm

CODICE	EAN		
752F50 D	8014130251715	60 cm	50x50 cm
752F50	8014130242256	120 cm	50x50 cm
752F50 A	8014130246254	150 cm	50x50 cm
752F50 B	8014130251692	180 cm	50x50 cm
752F50 C	8014130243697	200 cm	50x50 cm







Pala tonde

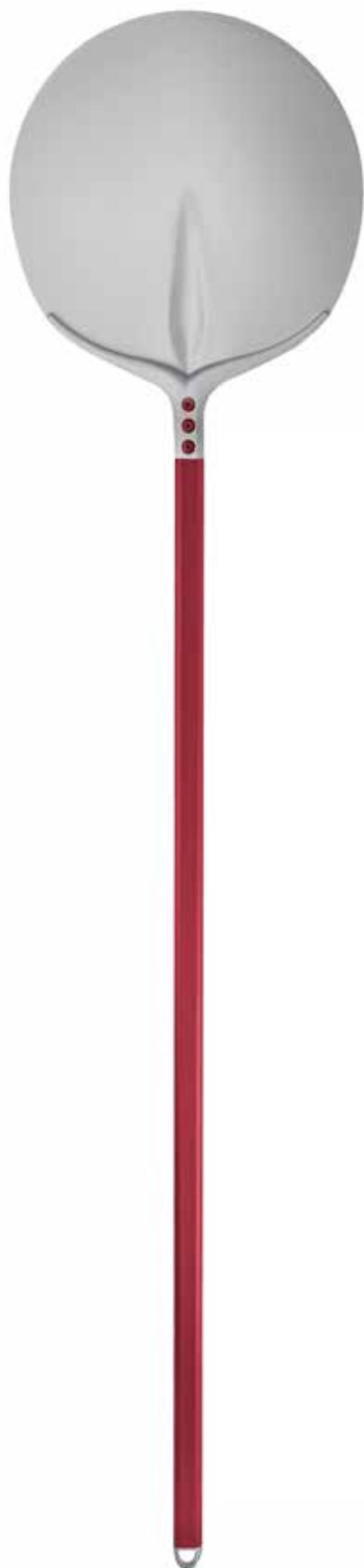

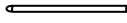
Cod. 750

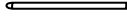

Pala tonda in alluminio anodizzato
Round pizza shovel in anodized aluminum



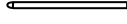

CODICE	EAN		
750/33 E	8014130223866	30 cm	ø33 cm
750/33 D	8014130223842	60 cm	ø33 cm
750/33	8014130232943	120 cm	ø33 cm
750/33 A	8014130231960	150 cm	ø33 cm
750/33 B	8014130232608	180 cm	ø33 cm
750/33 C	8014130242454	200 cm	ø33 cm

CODICE	EAN		
750/36 E	8014130240054	30 cm	ø36 cm
750/36 D	8014130223880	60 cm	ø36 cm
750/36	8014130232967	120 cm	ø36 cm
750/36 A	8014130231984	150 cm	ø36 cm
750/36 B	8014130232646	180 cm	ø36 cm
750/36 C	8014130244496	200 cm	ø36 cm

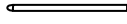

CODICE	EAN		
750/41 E	8014130244199	30 cm	ø41 cm
750/41 D	8014130244359	60 cm	ø41 cm
750/41	8014130232981	120 cm	ø41 cm
750/41 A	8014130232004	150 cm	ø41 cm
750/41 B	8014130232622	180 cm	ø41 cm
750/41 C	8014130244519	200 cm	ø41 cm



CODICE	EAN		
750/45 E	8014130223828	30 cm	ø45 cm
750/45 D	8014130223804	60 cm	ø45 cm
750/45	8014130231908	120 cm	ø45 cm
750/45 A	8014130232400	150 cm	ø45 cm
750/45 B	8014130232660	180 cm	ø45 cm
750/45 C	8014130244533	200 cm	ø45 cm



CODICE	EAN		
750/50 D	8014130251494	60 cm	ø50 cm
750/50	8014130251432	120 cm	ø50 cm
750/50 A	8014130246230	150 cm	ø50 cm
750/50 B	8014130251456	180 cm	ø50 cm
750/50 C	8014130251470	200 cm	ø50 cm

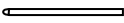

Pale tonde forate Cod. 750F

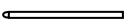

Pala tonda forata in alluminio anodizzato
Perforated round pizza shovel in anodized aluminum

CODICE	EAN		
750F33 E	8014130240672	30 cm	ø33 cm
750F33 D	8014130240955	60 cm	ø33 cm
750F33	8014130232028	120 cm	ø33 cm
750F33 A	8014130232349	150 cm	ø33 cm
750F33 B	8014130233520	180 cm	ø33 cm
750F33 C	8014130242119	200 cm	ø33 cm

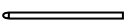
CODICE	EAN		
750F36 E	8014130244212	30 cm	ø36 cm
750F36 D	8014130242515	60 cm	ø36 cm
750F36	8014130232042	120 cm	ø36 cm
750F36 A	8014130232363	150 cm	ø36 cm
750F36 B	8014130240634	180 cm	ø36 cm
750F36 C	8014130244557	200 cm	ø36 cm

CODICE	EAN		
750F41 E	8014130244236	30 cm	ø41 cm
750F41 D	8014130244373	60 cm	ø41 cm
750F41	8014130232066	120 cm	ø41 cm
750F41 A	8014130233308	150 cm	ø41 cm
750F41 B	8014130244472	180 cm	ø41 cm
750F41 C	8014130244571	200 cm	ø41 cm

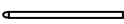
CODICE	EAN		
750F45 E	8014130244250	30 cm	ø45 cm
750F45 D	8014130244458	60 cm	ø45 cm
750F45	8014130231922	120 cm	ø45 cm
750F45 A	8014130233322	150 cm	ø45 cm
750F45 B	8014130240757	180 cm	ø45 cm
750F45 C	8014130244595	200 cm	ø45 cm

CODICE	EAN		
750F50 D	8014130251593	60 cm	ø50 cm
750F50	8014130251517	120 cm	ø50 cm
750F50 A	8014130251531	150 cm	ø50 cm
750F50 B	8014130251555	180 cm	ø50 cm
750F50 C	8014130251579	200 cm	ø50 cm

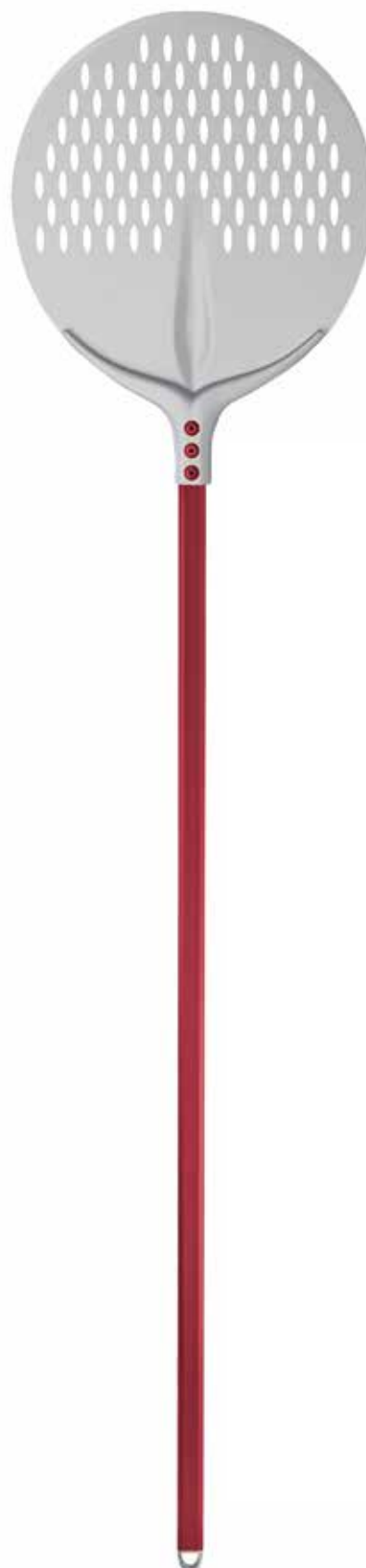





Pale rettangolari



Cod. 754



Pala rettangolare in alluminio anodizzato
Rectangular pizza shovel in anodized aluminum





CODICE	EAN		
7542440 D	8014130257359	60 cm	24x40 cm
7542440	8014130257366	120 cm	24x40 cm
7542440 A	8014130257373	150 cm	24x40 cm

CODICE	EAN		
7542460 D	8014130257380	60 cm	24x60 cm
7542460	8014130257397	120 cm	24x60 cm
7542460 A	8014130256550	150 cm	24x60 cm

CODICE	EAN		
7543060 D	8014130240771	60 cm	30x60 cm
7543060	8014130233360	120 cm	30x60 cm
7543060 A	8014130232745	150 cm	30x60 cm

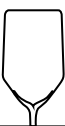
CODICE	EAN		
7543080 D	8014130233605	60 cm	30x80 cm
7543080	8014130233384	120 cm	30x80 cm
7543080 A	8014130233407	150 cm	30x80 cm

CODICE	EAN		
7544060 D	8014130240795	60 cm	40x60 cm
7544060	8014130240085	120 cm	40x60 cm
7544060 A	8014130233421	150 cm	40x60cm

CODICE	EAN		
7544080 D	8014130240818	60 cm	40x80 cm
7544080	8014130233445	120 cm	40x80 cm
7544080 A	8014130233469	150 cm	40x80 cm

Pale rettangolari forate

Cod. 754F

Pala rettangolare forata in alluminio anodizzato
Perforated rectangular pizza shovel in anodized aluminum

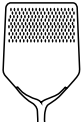
CODICE	EAN		
754F2440 D	8014130257403	60 cm	24X40 cm
754F2440	8014130257410	120 cm	24X40 cm
754F2440 A	8014130257427	150 cm	24X40 cm

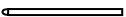
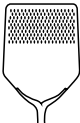
CODICE	EAN		
754F2460 D	8014130257434	60 cm	24X60 cm
754F2460	8014130257441	120 cm	24X60 cm
754F2460 A	8014130257458	150 cm	24X60 cm

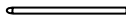
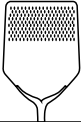
CODICE	EAN		
754F3060 D	8014130240856	60 cm	30x60 cm
754F3060	8014130232226	120 cm	30x60 cm
754F3060 A	8014130232721	150 cm	30x60 cm

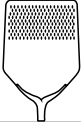
CODICE	EAN		
754F3080 D	8014130240870	60 cm	30x80 cm
754F3080	8014130232240	120 cm	30x80 cm
754F3080 A	8014130233483	150 cm	30x80 cm

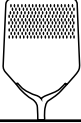
CODICE	EAN		
754F4060 D	8014130240436	60 cm	40x60 cm
754F4060	8014130232561	120 cm	40x60 cm
754F4060 A	8014130244434	150 cm	40x60 cm

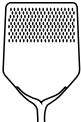
CODICE	EAN		
754F4080 D	8014130240832	60 cm	40x80 cm
754F4080	8014130232585	120 cm	40x80 cm
754F4080 A	8014130233506	150 cm	40x80 cm





Tulip

MADE IN ITALY





Designed by Itamar Harari

 I nostri 60 anni sono stati l'occasione per realizzare una nuova linea di pale con design innovativo. La foratura "a spiga" rende questa pala preziosa e le dona un pregio unico, rendendola inconfondibile. Realizzata secondo i più alti standard professionali, la Pala Tulip 60° Anniversario è composta da lega di alluminio anodizzato dotata di grande stabilità e robustezza, è l'ideale per sorreggere il peso degli impasti unitamente alla qualità e lavorazione del materiale che permette grande maneggevolezza e flessibilità, fondamentali nel lavoro di tutti i giorni.

Pale Pizza

ALLUMINIO ANODIZZATO

 L'**anodizzazione** dell'alluminio è un processo elettrochimico che applica una patina di ossido artificiale sulla lega metallica. Tecnicamente, l'ossido ricopre la superficie dell'alluminio dandogli maggiore resistenza nei confronti degli agenti atmosferici, dell'abrasione e una maggiore omogeneità della finitura.

 *Aluminum anodizing is an electrochemical process that applies an artificial oxide patina to the metal alloy. Technically, the oxide covers the surface of the aluminum giving it greater resistance to atmospheric agents, abrasion and greater homogeneity of the finish.*

 Our 60 years were the occasion to create a new line of shovels with an innovative design. The "wheat spike" perforation makes this shovel precious and gives it a unique value, making it unmistakable. Made according to the highest professional standards, the 60th Anniversary Tulip Shovel is made of anodized aluminum, with great stability and strength, it is ideal for supporting the weight of the dough together with the quality and processing of the material that allows great handling and flexibility, essential in everyday work.



FRESATURA FRONTALE

La speciale fresatura, crea la perfetta  aderenza fra pala e piano di lavoro, permettendo un'ottimale presa in carico della pizza.

The special milling creates perfect adherence between the shovel and the worktop, allowing an optimal sliding of the pizza. 



FORATURA "A SPIGA"

Fori "a spiga", che permettono una migliore fuoriuscita della farina, così da ottenere una cottura migliore senza bruciature. 

"Wheat spike" holes, which allow a better flow of flour, so as to obtain a better cooking without burning. 



RIVETTI

Utilizzati per garantire **robustezza e sicurezza** fra il  manico e la testa della pala.

Used to ensure strength and safety between the handle and the head of the shovel. 

NERVATURA

Questa speciale nervatura regala grande **stabilità** lasciando il  giusto spazio all'impasto.

This special rib gives great stability, leaving the right space for the dough. 



MADE IN ITALY



COLORE MANICO: Rosso 
HANDLE COLOR: Red 



Pale quadre forate

Cod. 762F

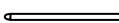
Pala quadra forata in alluminio anodizzato
Perforated square pizza shovel in anodized aluminum



CODICE	EAN		
762F33 E	8014130246797	30 cm	33x33 cm
762F33 D	8014130246773	60 cm	33x33 cm
762F33	8014130246698	120 cm	33x33 cm
762F33 A	8014130246711	150 cm	33x33 cm
762F33 B	8014130246735	180 cm	33x33 cm
762F33 C	8014130246759	200 cm	33x33 cm



CODICE	EAN		
762F36 E	8014130246919	30 cm	36x36 cm
762F36 D	8014130246896	60 cm	36x36 cm
762F36	8014130246810	120 cm	36x36 cm
762F36 A	8014130246834	150 cm	36x36 cm
762F36 B	8014130246858	180 cm	36x36 cm
762F36 C	8014130246872	200 cm	36x36 cm



Pale tonde forate

Cod. 760F

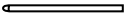
Pala tonda forata in alluminio anodizzato
 Perforated round pizza shovel in anodized aluminum

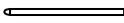

CODICE	EAN		
760F33 E	8014130246551	30 cm	ø33 cm
760F33 D	8014130246537	60 cm	ø33 cm
760F33	8014130246476	120 cm	ø33 cm
760F33 A	8014130246452	150 cm	ø33 cm
760F33 B	8014130246490	180 cm	ø33 cm
760F33 C	8014130246513	200 cm	ø33 cm

CODICE	EAN		
760F36 E	8014130246674	30 cm	ø36 cm
760F36 D	8014130246650	60 cm	ø36 cm
760F36	8014130246575	120 cm	ø36 cm
760F36 A	8014130246599	150 cm	ø36 cm
760F36 B	8014130246612	180 cm	ø36 cm
760F36 C	8014130246636	200 cm	ø36 cm



Tulip

MADE IN ITALY

GF

designed by Itamar Harari

ALLUMINIO ANODIZZATO

🇮🇹 L'**anodizzazione** dell'alluminio è un processo elettrochimico che applica una patina di ossido artificiale sulla lega metallica. Tecnicamente, l'ossido ricopre la superficie dell'alluminio dandogli maggiore resistenza nei confronti degli agenti atmosferici, dell'abrasione e una maggiore omogeneità della finitura.

🇬🇧 *Aluminum anodizing is an electrochemical process that applies an artificial oxide patina to the metal alloy. Technically, the oxide covers the surface of the aluminum giving it greater resistance to atmospheric agents, abrasion and greater homogeneity of the finish.*

🇮🇹 Pensata per soddisfare le esigenze di una ristorazione sempre più attenta alle richieste del cliente, la Pala Tulip GF è stata realizzata con il desiderio di semplificare il lavoro quotidiano di pizzaioli alle prese con impasti diversi che non devono entrare in contatto fra loro. Si distingue dalle linee Tulip e Tulip 60° Anniversario, grazie alla colorazione diversa ed elegante del manico che permetterà quindi al pizzaiolo di riconoscerla immediatamente.

🇬🇧 Designed to meet the needs of a food service industry that is increasingly attentive to customer requests, the Pala Tulip GF was created with the desire to simplify the daily work of pizza chefs struggling with different doughs that do not have to come into contact with each other. It stands out from the Tulip and Tulip 60th Anniversary lines, thanks to the different and elegant color of the handle which will therefore allow the pizza chef to recognize it immediately.

FRESATURA FRONTALE

La speciale **fresatura**, crea la perfetta aderenza fra pala ed il piano di lavoro, permettendo un'ottimale presa in carico della pizza.

The special milling creates the perfect adherence between the shovel and the worktop, allowing optimal sliding of the pizza.

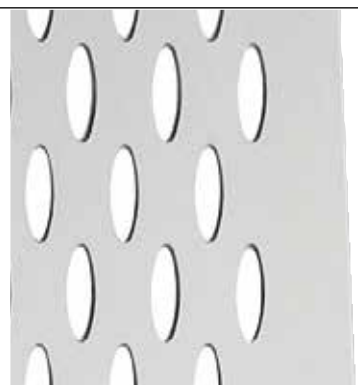

RIVETTI

Utilizzati per garantire **robustezza e sicurezza** fra il manico e la testa della pala.

Used to ensure strength and safety between the handle and the head of the shovel.

NERVATURA

Questa speciale nervatura regala grande **stabilità** lasciando il giusto spazio all'impasto.

This special rib gives great stability, leaving the right space for the dough.



MADE IN ITALY



COLORE MANICO: Grigio 🇮🇹
HANDLE COLOR: Grey 🇬🇧



Pala quadre



Cod. GF752

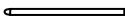

Pala quadra in alluminio anodizzato
Square pizza shovel in anodized aluminum



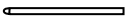

CODICE	EAN		
GF752/33 E	8014130248999	30 cm	33x33 cm
GF752/33 D	8014130248975	60 cm	33x33 cm
GF752/33	8014130248890	120 cm	33x33 cm
GF752/33 A	8014130248913	150 cm	33x33 cm
GF752/33 B	8014130248937	180 cm	33x33 cm
GF752/33 C	8014130248951	200 cm	33x33 cm

CODICE	EAN		
GF752/36 E	8014130250015	30 cm	36x36 cm
GF752/36 D	8014130249996	60 cm	36x36 cm
GF752/36	8014130249910	120 cm	36x36 cm
GF752/36 A	8014130249934	150 cm	36x36 cm
GF752/36 B	8014130249958	180 cm	36x36 cm
GF752/36 C	8014130249972	200 cm	36x36 cm

CODICE	EAN		
GF752/41 E	8014130250138	30 cm	41x41 cm
GF752/41 D	8014130250114	60 cm	41x41 cm
GF752/41	8014130250039	120 cm	41x41 cm
GF752/41 A	8014130250053	150 cm	41x41 cm
GF752/41 B	8014130250077	180 cm	41x41 cm
GF752/41 C	8014130250091	200 cm	41x41 cm

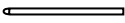

CODICE	EAN		
GF752/45 E	8014130250251	30 cm	45x45 cm
GF752/45 D	8014130250237	60 cm	45x45 cm
GF752/45	8014130250152	120 cm	45x45 cm
GF752/45 A	8014130250176	150 cm	45x45 cm
GF752/45 B	8014130250190	180 cm	45x45 cm
GF752/45 C	8014130250213	200 cm	45x45 cm



CODICE	EAN		
GF752/50 D	8014130250350	60 cm	50x50 cm
GF752/50	8014130250275	120 cm	50x50 cm
GF752/50 A	8014130250299	150 cm	50x50 cm
GF752/50 B	8014130250312	180 cm	50x50 cm
GF752/50 C	8014130250336	200 cm	50x50 cm



Pale quadre forate



Cod.GF752F



Pala quadra forata in alluminio anodizzato
Perforated square pizza shovel in anodized aluminum

CODICE	EAN		
GF752F33 E	8014130250473	30 cm	33x33 cm
GF752F33 D	8014130250459	60 cm	33x33 cm
GF752F33	8014130250374	120 cm	33x33 cm
GF752F33 A	8014130250398	150 cm	33x33 cm
GF752F33 B	8014130250411	180 cm	33x33 cm
GF752F33 C	8014130250435	200 cm	33x33 cm

CODICE	EAN		
GF752F36 E	8014130250596	30 cm	36x36 cm
GF752F36 D	8014130250572	60 cm	36x36 cm
GF752F36	8014130250497	120 cm	36x36 cm
GF752F36 A	8014130250510	150 cm	36x36 cm
GF752F36 B	8014130250534	180 cm	36x36 cm
GF752F36 C	8014130250558	200 cm	36x36 cm

CODICE	EAN		
GF752F41 E	8014130250718	30 cm	41x41 cm
GF752F41 D	8014130250695	60 cm	41x41 cm
GF752F41	8014130250619	120 cm	41x41 cm
GF752F41 A	8014130250633	150 cm	41x41 cm
GF752F41 B	8014130250657	180 cm	41x41 cm
GF752F41 C	8014130250671	200 cm	41x41 cm

CODICE	EAN		
GF752F45 E	8014130250831	30 cm	45x45 cm
GF752F45 D	8014130250817	60 cm	45x45 cm
GF752F45	8014130250732	120 cm	45x45 cm
GF752F45 A	8014130250756	150 cm	45x45 cm
GF752F45 B	8014130250770	180 cm	45x45 cm
GF752F45 C	8014130250794	200 cm	45x45 cm

CODICE	EAN		
GF752F50 D	8014130250930	60 cm	50x50 cm
GF752F50	8014130250855	120 cm	50x50 cm
GF752F50 A	8014130250879	150 cm	50x50 cm
GF752F50 B	8014130250893	180 cm	50x50 cm
GF752F50 C	8014130250916	200 cm	50x50 cm







Pala tonde

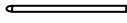

Cod. GF750



Pala tonda in alluminio anodizzato
Round pizza shovel in anodized aluminum



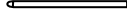

CODICE	EAN		
GF750/33 E	8014130247039	30 cm	ø33 cm
GF750/33 D	8014130247015	60 cm	ø33 cm
GF750/33	8014130246933	120 cm	ø33 cm
GF750/33 A	8014130246957	150 cm	ø33 cm
GF750/33 B	8014130246971	180 cm	ø33 cm
GF750/33 C	8014130246995	200 cm	ø33 cm

CODICE	EAN		
GF750/36 E	8014130247152	30 cm	ø36 cm
GF750/36 D	8014130247138	60 cm	ø36 cm
GF750/36	8014130247053	120 cm	ø36 cm
GF750/36 A	8014130247077	150 cm	ø36 cm
GF750/36 B	8014130247091	180 cm	ø36 cm
GF750/36 C	8014130247114	200 cm	ø36 cm

CODICE	EAN		
GF750/41 E	8014130247275	30 cm	ø41 cm
GF750/41 D	8014130247251	60 cm	ø41 cm
GF750/41	8014130247176	120 cm	ø41 cm
GF750/41 A	8014130247190	150 cm	ø41 cm
GF750/41 B	8014130247213	180 cm	ø41 cm
GF750/41 C	8014130247237	200 cm	ø41 cm

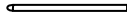

CODICE	EAN		
GF750/45 E	8014130247398	30 cm	ø45 cm
GF750/45 D	8014130247374	60 cm	ø45 cm
GF750/45	8014130247299	120 cm	ø45 cm
GF750/45 A	8014130247312	150 cm	ø45 cm
GF750/45 B	8014130247336	180 cm	ø45 cm
GF750/45 C	8014130247350	200 cm	ø45 cm



CODICE	EAN		
GF750/50 D	8014130247497	60 cm	ø50 cm
GF750/50	8014130247411	120 cm	ø50 cm
GF750/50 A	8014130247435	150 cm	ø50 cm
GF750/50 B	8014130247459	180 cm	ø50 cm
GF750/50 C	8014130247473	200 cm	ø50 cm

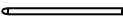

Pale tonde forate

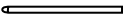

Cod. GF750F

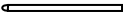

Pala tonda forata in alluminio anodizzato
Perforated round pizza shovel in anodized aluminum

CODICE	EAN		
GF750F33 E	8014130247619	30 cm	ø33 cm
GF750F33 D	8014130247596	60 cm	ø33 cm
GF750F33	8014130247510	120 cm	ø33 cm
GF750F33 A	8014130247534	150 cm	ø33 cm
GF750F33 B	8014130247558	180 cm	ø33 cm
GF750F33 C	8014130247572	200 cm	ø33 cm

CODICE	EAN		
GF750F36 E	8014130247732	30 cm	ø36 cm
GF750F36 D	8014130247718	60 cm	ø36 cm
GF750F36	8014130247633	120 cm	ø36 cm
GF750F36 A	8014130247657	150 cm	ø36 cm
GF750F36 B	8014130247671	180 cm	ø36 cm
GF750F36 C	8014130247695	200 cm	ø36 cm

CODICE	EAN		
GF750F41 E	8014130247855	30 cm	ø41 cm
GF750F41 D	8014130247831	60 cm	ø41 cm
GF750F41	8014130247756	120 cm	ø41 cm
GF750F41 A	8014130247770	150 cm	ø41 cm
GF750F41 B	8014130247794	180 cm	ø41 cm
GF750F41 C	8014130247817	200 cm	ø41 cm

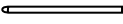
CODICE	EAN		
GF750F45 E	8014130247978	30 cm	ø45 cm
GF750F45 D	8014130247954	60 cm	ø45 cm
GF750F45	8014130247879	120 cm	ø45 cm
GF750F45 A	8014130247893	150 cm	ø45 cm
GF750F45 B	8014130247916	180 cm	ø45 cm
GF750F45 C	8014130247930	200 cm	ø45 cm

CODICE	EAN		
GF750F50 D	8014130248876	60 cm	ø50 cm
GF750F50	8014130247992	120 cm	ø50 cm
GF750F50 A	8014130248814	150 cm	ø50 cm
GF750F50 B	8014130248838	180 cm	ø50 cm
GF750F50 C	8014130248852	200 cm	ø50 cm







Pale rettangolari

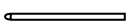

Cod. GF754



Pala rettangolare in alluminio anodizzato
Rectangular pizza shovel in anodized aluminum



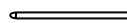

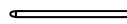

CODICE	EAN		
GF7542440D	8014130257519	60 cm	24x40 cm
GF7542440	8014130257526	120 cm	24x40 cm
GF7542440A	8014130257533	150 cm	24x40 cm

CODICE	EAN		
GF7542460D	8014130257540	60 cm	24x60 cm
GF7542460	8014130257557	120 cm	24x60 cm
GF7542460A	8014130257564	150 cm	24x60 cm

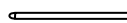
CODICE	EAN		
GF7543060 D	8014130250992	60 cm	30x60 cm
GF7543060	8014130250954	120 cm	30x60 cm
GF7543060 A	8014130250978	150 cm	30x60 cm

CODICE	EAN		
GF7543080 D	8014130251050	60 cm	30x80 cm
GF7543080	8014130251012	120 cm	30x80 cm
GF7543080 A	8014130251036	150 cm	30x80 cm

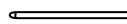
CODICE	EAN		
GF7544060 D	8014130251111	60 cm	40x60 cm
GF7544060	8014130251074	120 cm	40x60 cm
GF7544060 A	8014130251098	150 cm	40x60 cm

CODICE	EAN		
GF7544080 D	8014130251173	60 cm	40x80 cm
GF7544080	8014130251135	120 cm	40x80 cm
GF7544080 A	8014130251159	150 cm	40x80 cm

Pale rettangolari forate

Cod. GF754F

Pala rettangolare forata in alluminio anodizzato
Perforated rectangular pizza shovel in anodized aluminum

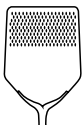
CODICE	EAN		
GF754F2440D	8014130257571	60 cm	24x40 cm
GF754F2440	8014130257588	120 cm	24x40 cm
GF754F2440A	8014130257595	150 cm	24x40 cm

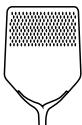
CODICE	EAN		
GF754F2460D	8014130257601	60 cm	24x60 cm
GF754F2460	8014130257618	120 cm	24x60 cm
GF754F2460A	8014130257625	150 cm	24x60 cm

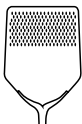
CODICE	EAN		
GF754F3060 D	8014130251234	60 cm	30x60 cm
GF754F3060	8014130251197	120 cm	30x60 cm
GF754F3060 A	8014130251210	150 cm	30x60 cm

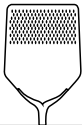
CODICE	EAN		
GF754F3080 D	8014130251296	60 cm	30x80 cm
GF754F3080	8014130251258	120 cm	30x80 cm
GF754F3080 A	8014130251272	150 cm	30x80 cm

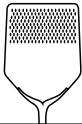
CODICE	EAN		
GF754F4060 D	8014130251357	60 cm	40x60 cm
GF754F4060	8014130251319	120 cm	40x60 cm
GF754F4060 A	8014130251333	150 cm	40x60 cm

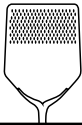

CODICE	EAN		
GF754F4080 D	8014130251418	60 cm	40x80 cm
GF754F4080	8014130251371	120 cm	40x80 cm
GF754F4080 A	8014130251395	150 cm	40x80 cm



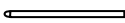

Pale quadre forate Cod. GF762F

Pala quadra forata in alluminio anodizzato
 Perforated square pizza shovel in anodized aluminum

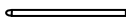

CODICE	EAN		
GF762F33 E	8014130253672	30 cm	33x33 cm
GF762F33 D	8014130253658	60 cm	33x33 cm
GF762F33	8014130253573	120 cm	33x33 cm
GF762F33 A	8014130253597	150 cm	33x33 cm
GF762F33 B	8014130253610	180 cm	33x33 cm
GF762F33 C	8014130253634	200 cm	33x33 cm



CODICE	EAN		
GF762F36 E	8014130253795	30 cm	36x36 cm
GF762F36 D	8014130253771	60 cm	36x36 cm
GF762F36	8014130253696	120 cm	36x36 cm
GF762F36 A	8014130253719	150 cm	36x36 cm
GF762F36 B	8014130253733	180 cm	36x36 cm
GF762F36 C	8014130253757	200 cm	36x36 cm



Pale tonde forate

Cod. GF760F

Pala tonda forata in alluminio anodizzato
Perforated round pizza shovel in anodized aluminum



CODICE	EAN		
GF760F33 E	8014130253436	30 cm	ø33 cm
GF760F33 D	8014130253412	60 cm	ø33 cm
GF760F33	8014130253337	120 cm	ø33 cm
GF760F33 A	8014130253351	150 cm	ø33 cm
GF760F33 B	8014130253375	180 cm	ø33 cm
GF760F33 C	8014130253399	200 cm	ø33 cm

CODICE	EAN		
GF760F36 E	8014130253559	30 cm	ø36 cm
GF760F36 D	8014130253535	60 cm	ø36 cm
GF760F36	8014130253450	120 cm	ø36 cm
GF760F36 A	8014130253474	150 cm	ø36 cm
GF760F36 B	8014130253498	180 cm	ø36 cm
GF760F36 C	8014130253511	200 cm	ø36 cm

Tulip

MADE IN ITALY

Pale Anodizzate Dure

Hard Anodized Shovels

ALLUMINIO ANODIZZATO DURO

🇮🇹 L'**anodizzazione dura** ad elevato spessore, avviene tramite un processo elettrolitico in immersione che forma uno strato di ossido di alluminio sulla superficie, che conferisce al pezzo una elevatissima resistenza alla corrosione ed un'eccezionale resistenza all'usura oltre che un maggiore scivolamento.

🇬🇧 *The hard, high-thickness anodizing takes place through an electrolytic immersion process that forms a layer of aluminum oxide on the surface, which gives the shovel a very high resistance to corrosion and exceptional wear resistance as well as greater slipping.*

🇮🇹 Realizzate in alluminio anodizzato duro, con manico in alluminio anodizzato grigio, questa Linea di pale nasce per soddisfare le richieste del pizzaiolo più esigente.

🇬🇧 Made of hard anodized aluminum, with grey anodized aluminum handle, this line of peels was created to meet the needs of the most demanding pizza chef.



FRESATURA FRONTALE

La speciale **fresatura**, crea la perfetta aderenza fra pala ed il piano di lavoro, permettendo un'ottimale scivolamento della pizza.

🇬🇧 *The special milling creates the perfect adherence between the shovel and the worktop, allowing optimal sliding of the pizza.*



RIVETTI

Utilizzati per garantire **robustezza e sicurezza** fra il manico e la testa della pala.

🇬🇧 *Used to ensure strength and safety between the handle and the head of the shovel.*

NERVATURA

Realizzata prendendo ispirazione dalla coda del delfino, questa speciale nervatura regala grande **stabilità** lasciando il giusto spazio all'impasto.

🇬🇧 *Made taking inspiration from the dolphin's tail, this special rib gives great stability, leaving the right space for the dough.*



ALLUMINIO ANODIZZATO 🇮🇹
Anodized Aluminum 🇬🇧

COLORE MANICO: Grigio 🇮🇹
HANDLE COLOR: Grey 🇬🇧



MADE IN ITALY



Pale Anodizzate Dure

Cod. AN 752F

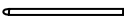
Hard Anodized Shovels

Pala quadra **forata** in alluminio anodizzato duro
Perforated square pizza shovel in hard anodized aluminum

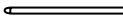
CODICE	EAN		
AN752F33E	8014130257953	30 cm	33x33 cm
AN752F33D	8014130253955	60 cm	33x33 cm
AN752F33	8014130253894	120 cm	33x33 cm
AN752F33A	8014130253917	150 cm	33x33 cm
AN752F33B	8014130253931	180 cm	33x33 cm

CODICE	EAN		
AN752F36E	8014130257960	30 cm	36x36 cm
AN752F36D	8014130254112	60 cm	36x36 cm
AN752F36	8014130254051	120 cm	36x36 cm
AN752F36A	8014130254075	150 cm	36x36 cm
AN752F36B	8014130254099	180 cm	36x36 cm







Pale Anodizzate Dure

Cod. AN 750F

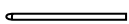
Hard Anodized Shovels

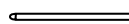

CODICE	EAN		
AN750F33/30	8014130257977	30 cm	Ø 33 cm
AN750F33/60	8014130256918	60 cm	Ø 33 cm
AN750F33/120	8014130256888	120 cm	Ø 33 cm
AN750F33/150	8014130256895	150 cm	Ø 33 cm
AN750F33/180	8014130256901	180 cm	Ø 33 cm



CODICE	EAN		
AN750F36/30	8014130257984	30 cm	Ø 36 cm
AN750F36/60	8014130256956	60 cm	Ø 36 cm
AN750F36/120	8014130256925	120 cm	Ø 36 cm
AN750F36/150	8014130256932	150 cm	Ø 36 cm
AN750F36/180	8014130256949	180 cm	Ø 36 cm



Pale Anodizzate Dure

Cod. AN 762F

Hard Anodized Shovels

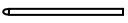

CODICE	EAN		
AN762F33/30	8014130256659	30 cm	33x33 cm
AN762F33/60	8014130256673	60 cm	33x33 cm
AN762F33/120	8014130256802	120 cm	33x33 cm
AN762F33/150	8014130256819	150 cm	33x33 cm
AN762F33/180	8014130256826	180 cm	33x33 cm



CODICE	EAN		
AN762F36/30	8014130256734	30 cm	36x36 cm
AN762F36/60	8014130256758	60 cm	36x36 cm
AN762F36/120	8014130256857	120 cm	36x36 cm
AN762F36/150	8014130256864	150 cm	36x36 cm
AN762F36/180	8014130256871	180 cm	36x36 cm

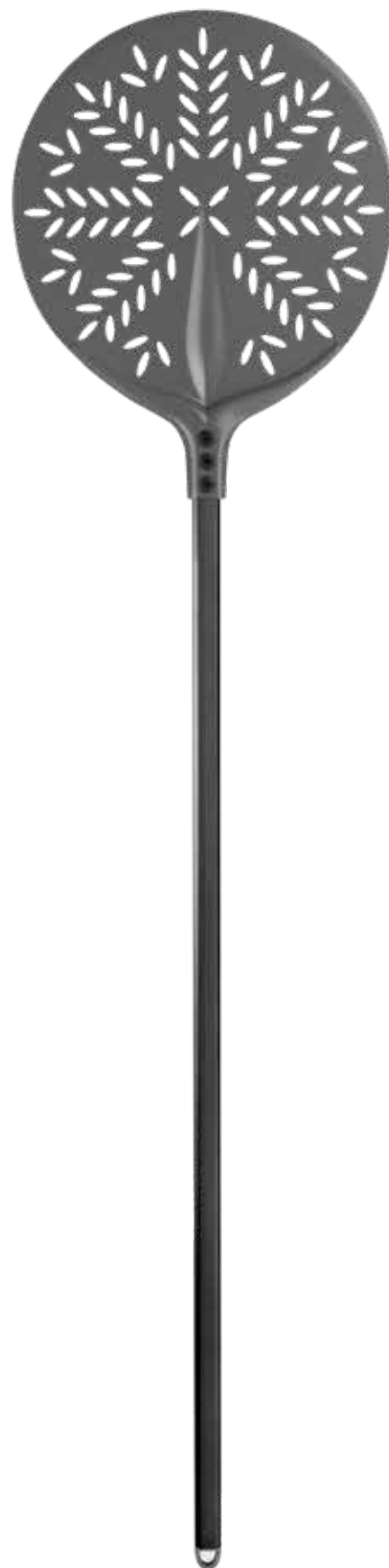

Pale Anodizzate Dure

Cod. AN 760F

Hard Anodized Shovels



CODICE	EAN		
AN760F33/30	8014130256697	30 cm	Ø 33 cm
AN760F33/60	8014130256710	60 cm	Ø 33 cm
AN760F33/120	8014130257465	120 cm	Ø 33 cm
AN760F33/150	8014130256963	150 cm	Ø 33 cm
AN760F33/180	8014130256970	180 cm	Ø 33 cm

CODICE	EAN		
AN760F36/30	8014130256772	30 cm	Ø 36 cm
AN760F36/60	8014130256796	60 cm	Ø 36 cm
AN760F36/120	8014130256994	120 cm	Ø 36 cm
AN760F36/150	8014130257007	150 cm	Ø 36 cm
AN760F36/180	8014130257014	180 cm	Ø 36 cm





Pale Smart

Destinate ad uso domestico
Intended for domestic use

ALLUMINATA

La principale caratteristica della **lamiera alluminata** utilizzata per la linea SMART risiede nell'eccellente resistenza alla corrosione ed anche alle alte temperature. Destinate ad un utilizzo domestico.

The main feature of the aluminized sheet used for the SMART line lies in its excellent resistance to corrosion and also to high temperatures. Intended for domestic use.



RIVETTI

Utilizzati per garantire **robustezza e sicurezza** fra il manico e la testa della pala.

Used to ensure strength and safety between the handle and the head of the shovel.

ALLUMINIO NON TRATTATO
Untreated Aluminum

COLORE MANICO: Alluminio naturale 
HANDLE COLOR: Natural aluminum 

MADE IN ITALY 

Pale Smart

Destinate ad uso domestico
Intended for domestic use



Realizzate in lamiera alluminata, dotate di un manico in alluminio non trattato, le pale della nuova linea SMART nascono per offrire pale più semplici ma soprattutto più accessibili, senza rinunciare alla qualità e robustezza dei materiali utilizzati e delle lavorazioni.

Made of aluminized sheet metal, equipped with an untreated aluminum handle, the shovels of the new SMART line have been designed to offer simpler but above all more accessible peels, without sacrificing the quality and robustness of the materials and processes used.

Destinate ad un utilizzo domestico.



Intended for domestic use.



Pale Smart



Cod. 795

Destinate ad un utilizzo domestico
Intended for domestic use



CODICE	EAN		
795/3030/30	8014130252279	30 cm	30x30 cm
795/3030/60	8014130252293	60 cm	30x30 cm
795/3030/120	8014130252316	120 cm	30x30 cm
795/3030/150	8014130252330	150 cm	30x30 cm
795/3030/180	8014130252354	180 cm	30x30 cm

CODICE	EAN		
795/3333/30	8014130252378	30 cm	33x33 cm
795/3333/60	8014130252392	60 cm	33x33 cm
795/3333/120	8014130252415	120 cm	33x33 cm
795/3333/150	8014130252439	150 cm	33x33 cm
795/3333/180	8014130252453	180 cm	33x33 cm



CODICE	EAN		
795/3636/30	8014130252477	30 cm	36x36 cm
795/3636/60	8014130252491	60 cm	36x36 cm
795/3636/120	8014130252514	120 cm	36x36 cm
795/3636/150	8014130252538	150 cm	36x36 cm
795/3636/180	8014130252552	180 cm	36x36 cm



Pale Smart forate

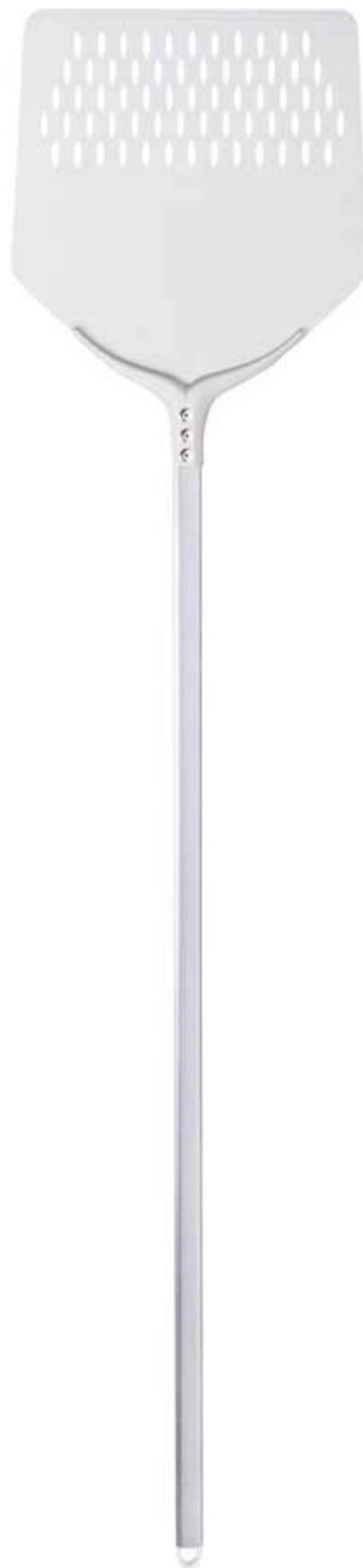

Cod. 796

Destinate ad un utilizzo domestico
Intended for domestic use



CODICE	EAN		
796/3030/30	8014130255973	30 cm	30x30 cm
796/3030/60	8014130255997	60 cm	30x30 cm
796/3030/120	8014130256017	120 cm	30x30 cm
796/3030/150	8014130256031	150 cm	30x30 cm
796/3030/180	8014130256055	180 cm	30x30 cm

CODICE	EAN		
796/3333/30	8014130256079	30 cm	33x33 cm
796/3333/60	8014130256093	60 cm	33x33 cm
796/3333/120	8014130256116	120 cm	33x33 cm
796/3333/150	8014130256130	150 cm	33x33 cm
796/3333/180	8014130256154	180 cm	33x33 cm

CODICE	EAN		
796/3636/30	8014130256178	30 cm	36x36 cm
796/3636/60	8014130256192	60 cm	36x36 cm
796/3636/120	8014130256215	120 cm	36x36 cm
796/3636/150	8014130256239	150 cm	36x36 cm
796/3636/180	8014130256253	180 cm	36x36 cm

Pale pizza al metro Cod. 759

designed by Itamar Harari

Pala pizza al metro in alluminio senza manico con tacche di riferimento sul lato, ogni 10 cm

Pizza shovel by the meter in aluminum with side notches every 10 cm and no handle

CODICE	EAN	
7592856	8014130241853	28x56 cm
7593376	8014130241815	33x76 cm
7593396	8014130241914	33x96 cm
7594176	8014130241952	41x76 cm
7594196	8014130241990	41x96 cm
75941111	8014130242034	41x111 cm



🇮🇹 Tacca di riferimento ogni 10 cm

🇬🇧 Side notches every 10 cm

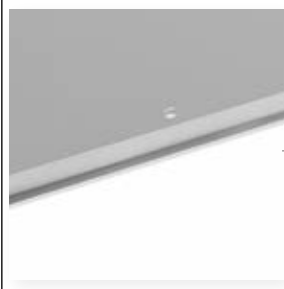

MADE IN ITALY



Pale pizza al metro

Cod. 759F

designed by Itamar Harari

Pala pizza al metro forata in alluminio senza manico con tacche di riferimento sul lato, ogni 10 cm

Perforated pizza shovel by the meter in aluminum with side notches every 10 cm and no handle

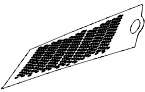
CODICE	EAN	
759F2856	8014130241877	28x56 cm
759F3376	8014130241839	33x76 cm
759F3396	8014130241938	33x96 cm
759F4176	8014130241976	41x76 cm
759F4196	8014130242010	41x96 cm
759F41111	8014130242058	41x111 cm

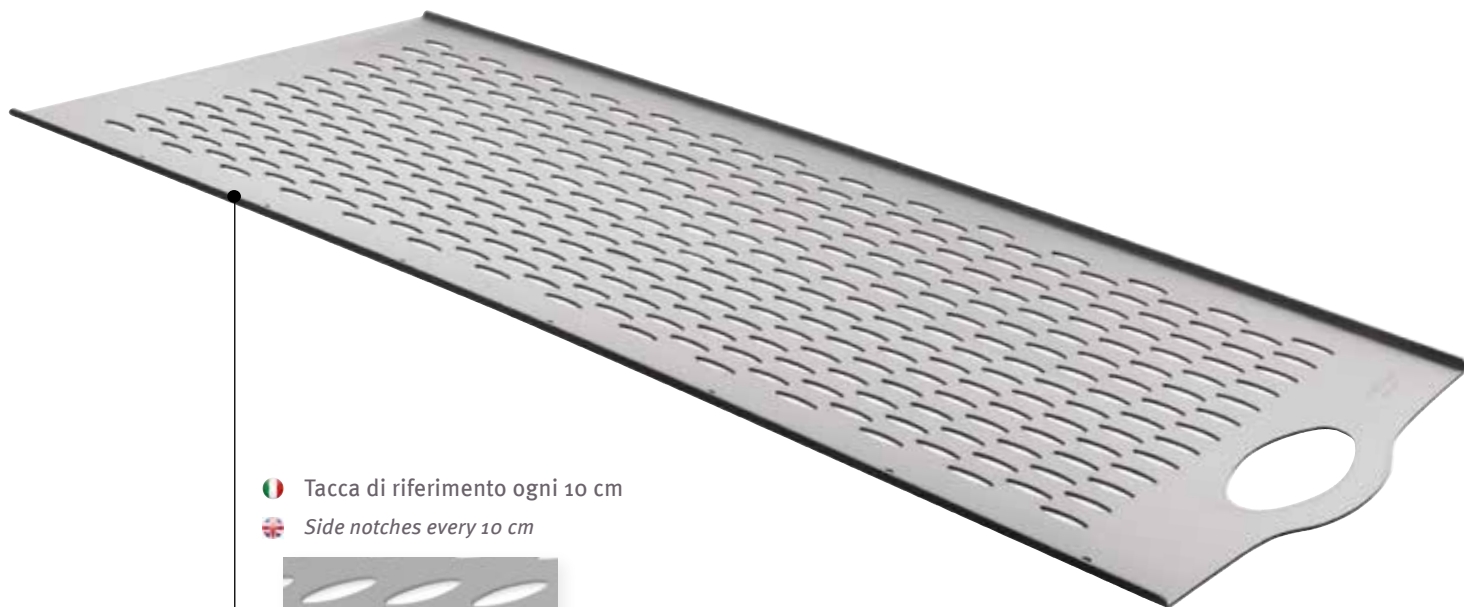

 Tacca di riferimento ogni 10 cm

 Side notches every 10 cm

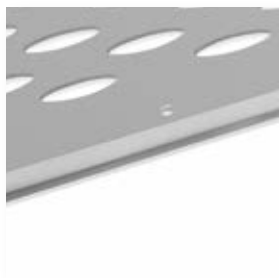

MADE IN ITALY



Pale a sfornare inox

Turning peels in stainless steel **designed by Itamar Harari**

Realizzato in acciaio inox, ideato per un utilizzo intensivo, offre pertanto una maggior maneggevolezza per un minor affaticamento del pizzaiolo.

Made of stainless steel, designed for intensive use, therefore offering greater handling and less fatigue for the pizza chef.

NUOVA FORATURA

Pala a sfornare in acciaio inox realizzata con una nuova foratura

Stainless steel turning peel made with a new perforation.



CODICE DESCRIZIONE

CODICE	DESCRIZIONE
MS1	acciaio / steel

Applicabile a qualsiasi modello di pala con manico in inox, permette di avere un manico smontabile ma con la rigidità e resistenza proprie del manico unico, questo è possibile grazie alla lavorazione di precisione delle parti che lo compongono.

Applicable to any model of shovel with stainless steel handle, it allows to have a removable handle but with the rigidity and resistance of the single handle, this is possible thanks to the precision machining of the parts that compose it.

Come ordinarlo? Aggiungendo al codice della pala desiderata il riferimento MS1 (es. 742/20/150 + MS1)

How to order? Add the reference MS1 to the code of the desired shovel (ex: 742/20/150 + MS1)



Fissaggio con ribattini per una maggiore tenuta meccanica



Fastening with rivets for greater mechanical strength



MADE IN ITALY

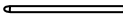

Pale a sfornare inox

Cod. 742F

Pala tonda forata in acciaio inox con manico in polimero **rosso** scorrevole
 Perforated round turning peels in stainless steel with **red** sliding handle

CODICE	EAN		
742F/18/60	8014130257496	60 cm	ø18 cm
742F/18/150	8014130257120	150 cm	ø18 cm
742F/18/180	8014130257137	180 cm	ø18 cm
742F/18/200	8014130257144	200 cm	ø18 cm

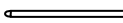
CODICE	EAN		
742F/21/60	8014130257502	60 cm	ø21 cm
742F/21/150	8014130257151	150 cm	ø21 cm
742F/21/180	8014130257168	180 cm	ø21 cm
742F/21/200	8014130257175	200 cm	ø21 cm



CODICE	EAN		
742F/24/60	8014130258035	60 cm	ø24 cm
742F/24/150	8014130257182	150 cm	ø24 cm
742F/24/180	8014130257199	180 cm	ø24 cm
742F/24/200	8014130257205	200 cm	ø24 cm





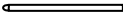

Pale a sfornare inox

Cod. 742F/G

Pala tonda forata in acciaio inox con manico in polimero **grigio** scorrevole
 Perforated round turning peels in stainless steel with **grey** sliding handle

CODICE	EAN		
742F/18/60/G	8014130257816	60 cm	ø18 cm
742F/18/150/G	8014130257724	150 cm	ø18 cm
742F/18/180/G	8014130257731	180 cm	ø18 cm
742F/18/200/G	8014130257748	200 cm	ø18 cm

CODICE	EAN		
742F/21/60/G	8014130258073	60 cm	ø21 cm
742F/21/150/G	8014130257755	150 cm	ø21 cm
742F/21/180/G	8014130257762	180 cm	ø21 cm
742F/21/200/G	8014130257779	200 cm	ø21 cm

CODICE	EAN		
742F/24/60/G	8014130258080	60 cm	ø24 cm
742F/24/150/G	8014130257786	150 cm	ø24 cm
742F/24/180/G	8014130257793	180 cm	ø24 cm
742F/24/200/G	8014130257809	200 cm	ø24 cm







Pale a sfornare inox

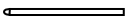

Cod. 742

Pala tonda in acciaio inox con manico in polimero **rosso** scorrevole
 Round turning peels in stainless steel with **red** sliding handle

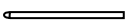

CODICE	EAN		
742/18/60	8014130257472	60 cm	ø18 cm
742/18/150	8014130257038	150 cm	ø18 cm
742/18/180	8014130257045	180 cm	ø18 cm
742/18/200	8014130257052	200 cm	ø18 cm

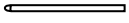
CODICE	EAN		
742/21/60	8014130257489	60 cm	ø21 cm
742/21/150	8014130257069	150 cm	ø21 cm
742/21/180	8014130257076	180 cm	ø21 cm
742/21/200	8014130257083	200 cm	ø21 cm



CODICE	EAN		
742/24/60	8014130258028	60 cm	ø24 cm
742/24/150	8014130257090	150 cm	ø24 cm
742/24/180	8014130257106	180 cm	ø24 cm
742/24/200	8014130257113	200 cm	ø24 cm



Pale a sfornare inox

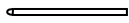

Cod. 742/G

Pala tonda in acciaio inox con manico in polimero **grigio** scorrevole

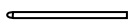
Round turning peels in stainless steel with **grey** sliding handle

CODICE	EAN		
742/18/60/G	8014130258042	60 cm	ø18 cm
742/18/150/G	8014130257632	150 cm	ø18 cm
742/18/180/G	8014130257649	180 cm	ø18 cm
742/18/200/G	8014130257656	200 cm	ø18 cm

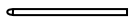
CODICE	EAN		
742/21/60/G	8014130258059	60 cm	ø21 cm
742/21/150/G	8014130257663	150 cm	ø21 cm
742/21/180/G	8014130257670	180 cm	ø21 cm
742/21/200/G	8014130257687	200 cm	ø21 cm

CODICE	EAN		
742/24/60/G	8014130258066	60 cm	ø24 cm
742/24/150/G	8014130257694	150 cm	ø24 cm
742/24/180/G	8014130257700	180 cm	ø24 cm
742/24/200/G	8014130257717	200 cm	ø24 cm





Pale a sfornare inox



Pala tonda in acciaio inox con manico in polimero **rosso** scorrevole
Round turning peels in stainless steel with **red** sliding handle







Pale Tonde - Cod. 720



Round Shovels

CODICE	EAN		
720/15/60	8014130257212	60 cm	ø15cm
720/15/150	8014130232264	150 cm	ø15cm
720/15/180	8014130245714	180 cm	ø15cm
720/15/200	8014130245738	200 cm	ø15cm

CODICE	EAN		
720/20/60	8014130256611	60 cm	ø20 cm
720/20/150	8014130232288	150 cm	ø20 cm
720/20/180	8014130243673	180 cm	ø20 cm
720/20/200	8014130245752	200 cm	ø20cm



CODICE	EAN		
720/25/60	8014130257229	60 cm	ø25 cm
720/25/150	8014130232301	150 cm	ø25 cm
720/25/180	8014130242379	180 cm	ø25 cm
720/25/200	8014130245776	200 cm	ø25cm



CODICE	EAN		
720/30/60	8014130257236	60 cm	ø30 cm
720/30/150	8014130232325	150 cm	ø30 cm
720/30/180	8014130245790	180 cm	ø30 cm
720/30/200	8014130245813	200 cm	ø30cm

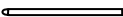

CODICE	EAN		
720/35/60	8014130257243	60 cm	ø35 cm
720/35/150	8014130232448	180 cm	ø35 cm
720/35/180	8014130245837	200 cm	ø35 cm
720/35/200	8014130245851	200 cm	ø35 cm

Pale Tonde Forate - Cod. 730

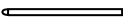
Perforated Round Shovels

CODICE	EAN		
730/15/60	8014130257250	60 cm	ø15 cm
730/15/150	8014130251791	150 cm	ø15 cm
730/15/180	8014130251814	180 cm	ø15 cm
730/15/200	8014130251838	200 cm	ø15 cm

CODICE	EAN		
730/20/60	8014130256635	60 cm	ø20 cm
730/20/150	8014130251852	150 cm	ø20 cm
730/20/180	8014130251876	180 cm	ø20 cm
730/20/200	8014130251890	200 cm	ø20 cm

CODICE	EAN		
730/25/60	8014130257267	60 cm	ø25 cm
730/25/150	8014130251913	150 cm	ø25 cm
730/25/180	8014130251937	180 cm	ø25 cm
730/25/200	8014130251951	200 cm	ø25 cm





Pale a sfornare inox



Pala tonda in acciaio inox con manico in polimero **grigio** scorrevole
 Round turning peels in stainless steel with **grey** sliding handle





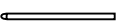

Pale Tonde - Cod. 720/G

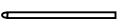

Round Shovels

CODICE	EAN		
720/15/60/G	8014130258097	60 cm	ø15cm
720/15/150/G	8014130258103	150 cm	ø15cm
720/15/180/G	8014130258110	180 cm	ø15cm
720/15/200/G	8014130258127	200 cm	ø15cm

CODICE	EAN		
720/20/60/G	8014130258134	60 cm	ø20 cm
720/20/150/G	8014130258141	150 cm	ø20 cm
720/20/180/G	8014130258158	180 cm	ø20 cm
720/20/200/G	8014130258165	200 cm	ø20cm



CODICE	EAN		
720/25/60/G	8014130258172	60 cm	ø25 cm
720/25/150/G	8014130258189	150 cm	ø25 cm
720/25/180/G	8014130258196	180 cm	ø25 cm
720/25/200/G	8014130258202	200 cm	ø25cm



CODICE	EAN		
720/30/60/G	8014130258813	60 cm	ø30 cm
720/30/150/G	8014130258219	150 cm	ø30 cm
720/30/180/G	8014130258226	180 cm	ø30 cm
720/30/200/G	8014130258233	200 cm	ø30cm

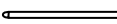

CODICE	EAN		
720/35/60/G	8014130258820	60 cm	ø35 cm
720/35/150/G	8014130258240	180 cm	ø35 cm
720/35/180/G	8014130258257	200 cm	ø35 cm
720/35/200/G	8014130258264	200 cm	ø35 cm

Pale Tonde Forate - Cod. 730/G

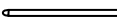
Perforated Round Shovels

CODICE	EAN		
730/15/60/G	8014130258271	60 cm	ø15 cm
730/15/150/G	8014130258288	150 cm	ø15 cm
730/15/180/G	8014130258295	180 cm	ø15 cm
730/15/200/G	8014130258301	200 cm	ø15 cm

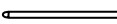
CODICE	EAN		
730/20/60/G	8014130258318	60 cm	ø20 cm
730/20/150/G	8014130258325	150 cm	ø20 cm
730/20/180/G	8014130258332	180 cm	ø20 cm
730/20/200/G	8014130258349	200 cm	ø20 cm

CODICE	EAN		
730/25/60/G	8014130258356	60 cm	ø25 cm
730/25/150/G	8014130258363	150 cm	ø25 cm
730/25/180/G	8014130258370	180 cm	ø25 cm
730/25/200/G	8014130258387	200 cm	ø25 cm





KIT Linea Tulip

Composto da Composed of:

- 1 x Pala pizza quadra Linea Tulip 33x33 cm, manico 120 cm
- 1 x Pala a sfornare ø21 cm, manico scorrevole 150 cm
- 1 x Spazzola 18 cm, manico in alluminio e raschiatore, 150 cm
- 1 x Square pizza shovel Tulip 33x33 cm, handle 120 cm
- 1 x SS turning peel ø21 cm, sliding handle 150 cm
- 1 x Wooden brush 18 cm, aluminium handle and scraper 150 cm

CODICE	EAN	COMPOSTO DA
KIT752/3	8014130257274	cod. 752/33 cod. 742/21/150 cod. AL-RA2764/18



KIT Linea Tulip Forata

Composto da Composed of:

- 1 x Pala pizza quadra forata Linea Tulip 33x33 cm, manico 120 cm
- 1 x Pala a sfornare forata ø21 cm, manico scorrevole 150 cm
- 1 x Spazzola 18 cm, manico in alluminio e raschiatore, 150 cm
- 1 x Perforated square pizza shovel Tulip 33x33 cm, handle 120 cm
- 1 x Perforated SS turning peel ø21 cm, sliding handle 150 cm
- 1 x Wooden brush 18 cm, aluminium handle and scraper 150 cm

CODICE	EAN	COMPOSTO DA
KIT752F/3	8014130257281	cod. 752F33 cod. 742F/21/150 cod. AL-RA2764/18



KIT 60° anniversario

Composto da Composed of:

- 1 x Pala pizza quadra forata Linea Tulip 60° 33x33 cm forata, manico 120 cm
- 1 x Pala a sfornare forata, ø21 cm, manico scorrevole 150 cm
- 1 x Spazzola 18 cm, manico in alluminio e raschiatore, 150 cm
- 1 x Perforated square pizza shovel Tulip 60° 33x33 cm, handle 120 cm
- 1 x Perforated SS turning peel ø21 cm, sliding handle 150 cm
- 1 x Wooden brush 18 cm, aluminium handle and scraper 150 cm

CODICE	EAN	COMPOSTO DA
KIT60/3	8014130257298	cod. 762F33 cod. 742F/21/150 cod. AL-RA2764/18



KIT Linea Smart

Composto da Composed of:

- 1 x Pala pizza quadra Linea Smart 30x30 cm, manico 120 cm
- 1 x Palotto in acciaio inox ø20 cm, manico scorrevole 150 cm
- 1 x Spazzola 18 cm, manico in acciaio inox, 150cm
- 1 x Square pizza shovel Smart 30x30 cm, handle 120 cm
- 1 x SS turning peel ø20 cm, sliding handle 150 cm
- 1 x Wooden brush 18 cm, w/inox handle 150 cm

CODICE	EAN	COMPOSTO DA
KIT795/3	8014130257304	cod. 795/3030/120 cod. 720/20/150 cod. 2764/18

Disponibile anche in versione manico grigio
Also available with grey handle

Espositore porta pale

Shovels holder display



Espositore Porta Pale e accessori

Shovels holder and accessories display

CODICE	EAN	DIMENSIONE
---------------	------------	-------------------

800	8014130256833	120X40X210H.cm
-----	---------------	----------------

PROLUNGHE ESPOSITORI / DISPLAY EXTENSIONS		
--	--	--

PROL800	8014130257311	H cm. 30
---------	---------------	----------

Espositore senza prolunghe: Luce massima interna cm. 175, esterna cm.200
c/ prolunghe: Luce massima interna cm. 200, esterna cm.235

Display without extensions: Maximum internal space cm. 175, external cm.200
With extensions: Maximum internal space cm.200, external cm.235



Accessori pizzeria

Pizza Accessories:

- Pale per brace/cenere
Ash shovels
- Spazzole
Brushes
- Porta pale
Shovels holder
- Cucchiai, palette, rotelle
Spoons, Spatulas and wheels
- Cassette pizza
Pizza box
- Olierone
Oil server
- Retine
Pizza screen
- Borse/zaini termici per pizza
Thermal pizza bags

Accessori pizzeria

Indispensabili nella cucina di ogni pizzeria, ma anche nelle case di ogni vero appassionato della pizza. Cerutti Inox offre non solo pale pizza, ma anche un'intera gamma di accessori utili alla sua preparazione. Dalle teglie, oliere, rotelle, spatole fino alle spazzole per l'essenziale pulizia del forno e alle pale per tirare la cenere.

Pale per brace e cenere

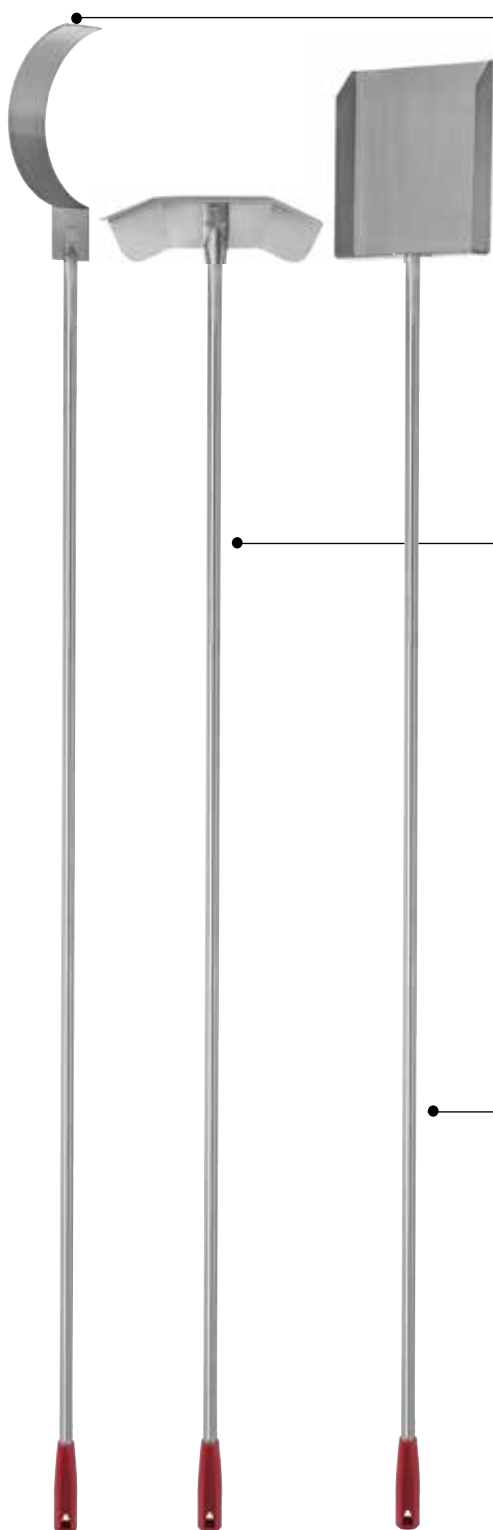

Pala ricurva sposta brace in acciaio inox Ember mover in stainless steel

Dimensioni: 25x7,5 cm

CODICE	EAN	
2762	8014130231823	150 cm
2762B	8014130246391	180 cm
2762C	8014130252750	200 cm

Pala tira brace in acciaio inox Ember spreader in stainless steel

Dimensioni: 23x8 cm

CODICE	EAN	
2763	8014130231809	150 cm
2763B	8014130246438	180 cm
2763C	8014130253115	200 cm

Pala raccogli cenere in acciaio inox Shovel for ash in stainless steel

Dimensioni: 50x5 cm

CODICE	EAN	
2761	8014130231854	150 cm
2761B	8014130246377	180 cm
2761C	8014130252736	200 cm

Per versione con manico di colore grigio, aggiungere al codice prodotto /G
To order the grey handle version, add /G to the product code

Pizza Accessories

🇬🇧 Essential in the kitchen of every pizzeria, but also in the homes of every true pizza lover. Cerutti Inox offers not only pizza shovels, but also a whole range of accessories useful for its preparation. From baking pans, oil servers, wheels, spatulas to brushes for the essential cleaning of the oven and shovels to pull the ashes.

Spazzole Brushes

SETOLE NATURALI / NATURAL BRISTLES

Spazzola in legno, realizzata con setole in fibra naturale, ideale per una pulizia **delicata** ed efficace del forno, pulisce facilmente residui di cenere e farina senza danneggiare la superficie. 🇮🇹

Wooden brush, made with natural bristles, ideal for a gentle cleaning of the oven, it easily cleans residues of ash and flour. 🇬🇧



SETOLE DI OTTONE / BRASS BRISTLES

Spazzola in legno, realizzata con setole di ottone, ideale per una pulizia **veloce ed efficace** del forno, pulisce facilmente residui di cenere e farina. 🇮🇹

Wooden brush, made with brass bristles, ideal for a fast and effective cleaning of the oven, it easily cleans residues of ash and flour. 🇬🇧



SETOLE DI OTTONE - Tonda/ BRASS BRISTLES - ROUND

Spazzola in legno, realizzata con setole di ottone, ideale per una pulizia **veloce ed efficace** del forno, pulisce facilmente residui di cenere e farina. La forma tonda permette di raggiungere ogni angolo del forno. 🇮🇹

Wooden brush, made with brass bristles, ideal for a fast and effective cleaning of the oven, it easily cleans residues of ash and flour. The round shape allows you to reach every corner of the oven. 🇬🇧



SETOLE ACCIAIO "GRILL"/ STEEL BRISTLES "GRILL"

Spazzola in legno, realizzata con setole in acciaio, ideale per una pulizia **intensiva ed efficace**, pulisce facilmente residui, anche più difficili. 🇮🇹

Wooden brush, made with steel bristles, ideal for an intensive and effective cleaning, it easily cleans residues, even the most difficult ones. 🇬🇧



Spazzole Brushes Manici Handles

Manico in acciaio inossidabile
Stainless steel handle



ACCIAIO INOX
Stainless Steel

🇮🇹 Misure disponibili
🇬🇧 Available sizes:
150 cm
180 cm
200cm



Manico in alluminio anodizzato con raschiatore
Anodized aluminium handle with scraper



RASCHIATORE
Scraper



ALLUMINIO ANODIZZATO
Anodized aluminum

🇮🇹 Misure disponibili
🇬🇧 Available sizes:
150 cm
180 cm
200cm

SENZA MANICO
Without handle

🇮🇹 Setole: Ottone
🇬🇧 Bristles: Brass



IMPUGNATURA MANUALE
Manual handle

SETOLE
Bristles

🇮🇹 Setole: Acciaio
🇬🇧 Bristles: Steel



Spazzole Brushes Ottone Brass



Spazzole in legno con setole in ottone e manico **rosso**
Wooden brush with brass bristles and **red** handle

Dimensioni: **18 cm**



Spazzola rettangolare in legno e manico
in acciaio inox

Rectangular wooden brush, stainless steel handle



CODICE	EAN		
2764/18D	8014130258790	18 cm	60 cm
2764/18	8014130240078	18 cm	150 cm
2764/18B	8014130246278	18 cm	180 cm
2764/18C	8014130252897	18 cm	200 cm

Dimensioni: **22,5 cm**



Spazzola rettangolare in legno e manico in
acciaio inox



Rectangular wooden brush, stainless steel handle

CODICE	EAN		
2764/22	8014130231946	22,5 cm	150 cm
2764/22B	8014130243758	22,5 cm	180 cm
2764/22C	8014130241273	22,5 cm	200 cm



Spazzola rettangolare in legno con manico in
alluminio e raschiatore



Rectangular wooden brush, aluminum handle
and scraper

CODICE	EAN		
AL-RA2764/18D	8014130258806	18 cm	60 cm
AL-RA2764/18	8014130253030	18 cm	150 cm
AL-RA2764/18B	8014130254174	18 cm	180 cm
AL-RA2764/18C	8014130254198	18 cm	200 cm



Spazzola rettangolare in legno con manico in
alluminio e raschiatore



Rectangular wooden brush, aluminum handle
and scraper

CODICE	EAN		
AL-RA2764/22	8014130253054	22,5 cm	150 cm
AL-RA2764/22B	8014130254211	22,5 cm	180 cm
AL-RA2764/22C	8014130254235	22,5 cm	200 cm



Spazzola rettangolare in legno con manico in
alluminio non trattato

Rectangular wooden brush, aluminum handle

CODICE	EAN		
AL-2764/18D	8014130256574	18 cm	60 cm
AL-2764/18	8014130254396	18 cm	120 cm
AL-2764/18B	8014130254419	18 cm	150 cm



Spazzola rettangolare in legno senza manico
Rectangular wooden brush, no handle

CODICE	EAN	DIMENSIONE
2764/S18	8014130240153	18 cm

Spazzole Brushes Ottone Brass

Spazzole in legno con setole in ottone e manico **grigio**
Wooden brush with brass bristles and **grey** handle

Dimensioni: **18 cm**



Spazzola rettangolare in legno e manico
in acciaio inox

Rectangular wooden brush, stainless steel handle

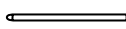
CODICE	EAN		
2764/18D/G	8014130258547	18 cm	60 cm
2764/18/G	8014130258516	18 cm	150 cm
2764/18B/G	8014130258523	18 cm	180 cm
2764/18C/G	8014130258530	18 cm	200 cm

Dimensioni: **22,5 cm**



Spazzola rettangolare in legno e manico in
acciaio inox

Rectangular wooden brush, stainless steel handle

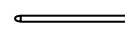
CODICE	EAN		
2764/22/G	8014130258554	22,5 cm	150 cm
2764/22B/G	8014130258561	22,5 cm	180 cm
2764/22C/G	8014130258578	22,5 cm	200 cm



Spazzola rettangolare in legno con manico in
alluminio e raschiatore

Rectangular wooden brush, aluminum handle
and scraper

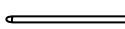
CODICE	EAN		
AL-RA2764/18D/G	8014130258783	18 cm	60 cm
AL-RA2764/18/G	8014130257830	18 cm	150 cm
AL-RA2764/18B/G	8014130258684	18 cm	180 cm
AL-RA2764/18C/G	8014130258691	18 cm	200 cm



Spazzola rettangolare in legno con manico in
alluminio e raschiatore

Rectangular wooden brush, aluminum handle
and scraper

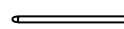
CODICE	EAN		
AL-RA2764/22/G	8014130257861	22,5 cm	150 cm
AL-RA2764/22B/G	8014130258707	22,5 cm	180 cm
AL-RA2764/22C/G	8014130258714	22,5 cm	200 cm

Spazzole Brushes Ottone Brass

Spazzole in legno con setole in ottone e manico **rosso**

Wooden brush with brass bristles and **red** handle

Dimensioni: **30 cm**



Spazzola rettangolare in legno e manico in acciaio inox

Rectangular wooden brush, stainless steel handle

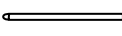
CODICE	EAN		
2764/27	8014130241297	30 cm	150 cm
2764/27B	8014130242393	30 cm	180 cm
2764/27C	8014130246414	30 cm	200 cm

Dimensioni: **Ø19 cm**



Spazzola tonda in legno e manico in acciaio inox

Round wooden brush, stainless steel handle

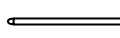
CODICE	EAN		
2760	8014130231885	Ø19 cm	150 cm
2760B	8014130243710	Ø19 cm	180 cm
2760C	8014130252712	Ø19 cm	200 cm



Spazzola rettangolare in legno con manico in alluminio e raschiatore

Rectangular wooden brush, aluminum handle and scraper

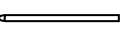
CODICE	EAN		
AL-RA2764/27	8014130253078	30 cm	150 cm
AL-RA2764/27B	8014130254259	30 cm	180 cm
AL-RA2764/27C	8014130254273	30 cm	200 cm

Spazzola tonda in legno con manico in alluminio e raschiatore

Round wooden brush, aluminum handle and scraper

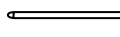
CODICE	EAN		
AL-RA2760	8014130253016	Ø19 cm	150 cm
AL-RA2760/B	8014130254136	Ø19 cm	180 cm
AL-RA2760/C	8014130254150	Ø19 cm	200 cm



Ricambi

Ricambio spazzola rettangolare in legno, setole ottone
Replacement rectangular wooden brush, brass bristles

CODICE	EAN	DIMENSIONE
2764/R18	8014130243772	18 cm
2764/R22	8014130241310	22,5 cm
2764/R27	8014130241334	30 cm



Ricambi

Ricambio spazzola tonda in legno, setole ottone
Replacement round wooden brush, brass bristles

CODICE	EAN	DIMENSIONE
2760RIC	8014130254716	Ø19 cm

Spazzole Brushes Ottone Brass

Spazzole in legno con setole in ottone e manico **grigio**
Wooden brush with brass bristles and **grey** handle

Dimensioni: **30 cm**

Dimensioni: **Ø19 cm**

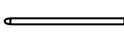

Spazzola rettangolare in legno e manico in acciaio inox
Rectangular wooden brush, stainless steel handle

CODICE	EAN		
2764/27/G	8014130258585	30 cm	150 cm
2764/27B/G	8014130258592	30 cm	180 cm
2764/27C/G	8014130258608	30 cm	200 cm



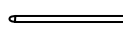

Spazzola tonda in legno e manico in acciaio inox
Round wooden brush, stainless steel handle

CODICE	EAN		
2760/G	8014130258486	Ø19 cm	150 cm
2760B/G	8014130258493	Ø19 cm	180 cm
2760C/G	8014130258509	Ø19 cm	200 cm



Spazzola rettangolare in legno con manico in alluminio e raschiatore
Rectangular wooden brush, aluminum handle and scraper

CODICE	EAN		
AL-RA2764/27/G	8014130258721	30 cm	150 cm
AL-RA2764/27B/G	8014130258738	30 cm	180 cm
AL-RA2764/27C/G	8014130258745	30 cm	200 cm

Spazzola tonda in legno con manico in alluminio e raschiatore
Round wooden brush, aluminum handle and scraper

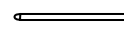
CODICE	EAN		
AL-RA2760/G	8014130258653	Ø19 cm	150 cm
AL-RA2760/B/G	8014130258660	Ø19 cm	180 cm
AL-RA2760/C/G	8014130258677	Ø19 cm	200 cm

Spazzole Brushes

Setole Naturali

Natural bristles

Dimensioni: **22,5 cm**



Spazzola rettangolare in legno e manico in acciaio inox

Rectangular wooden brush, stainless steel handle

CODICE

EAN



2770/D	8014130256598	22,5 cm	60 cm
2770	8014130252910	22,5 cm	150 cm
2770/B	8014130254433	22,5 cm	180 cm
2770/C	8014130254457	22,5 cm	200 cm



Spazzola rettangolare in legno con manico in alluminio e raschiatore

Wooden rectangular brush, aluminum handle and scraper

CODICE

EAN

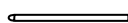

AL-RA2770	8014130253092	22,5 cm	150 cm
AL-RA2770/B	8014130254471	22,5 cm	180 cm
AL-RA2770/C	8014130254495	22,5 cm	200 cm



Ricambi

Ricambio spazzola rettangolare in legno setole naturali

Replacement rectangular wooden brush, natural bristles

CODICE

EAN

DIMENSIONE

2770/R	8014130254518	22,5 cm
--------	---------------	---------

Setole Acciaio "Grill"

Steel bristles "Grill"

Dimensioni: **13 cm**



Spazzola rettangolare in legno con impugnatura manuale

Rectangular wooden brush, with manual handle

CODICE

EAN

DIMENSIONE

2780/M	8014130254730	30x4x5 cm
--------	---------------	-----------



Ricambi

Ricambio spazzola rettangolare in legno setole acciaio

Replacement rectangular wooden brush, steel bristles

CODICE

EAN

DIMENSIONE

2780/R	8014130254358	16 cm
--------	---------------	-------

Spazzole Brushes

Setole Naturali



Natural bristles

Dimensioni: 22,5 cm



Spazzola rettangolare in legno e manico in acciaio
inox



Rectangular wooden brush, stainless steel handle

CODICE	EAN		
2770/D/G	8014130258646	22,5 cm	60 cm
2770/G	8014130258615	22,5 cm	150 cm
2770/B/G	8014130258622	22,5 cm	180 cm
2770/C/G	8014130258639	22,5 cm	200 cm



Spazzola rettangolare in legno con manico in
alluminio e raschiatore

Wooden rectangular brush, alluminum handle
and scraper

CODICE	EAN		
AL-RA2770/G	8014130258752	22,5 cm	150 cm
AL-RA2770/B/G	8014130258769	22,5 cm	180 cm
AL-RA2770/C/G	8014130258776	22,5 cm	200 cm



Porta pale Shovels holder

Portapala a pavimento FIAMMA e SUMO con sostegno 3 posti tappetino in gomma
Floor bracket FIAMMA and SUMO with 3 slots and rubber mat

 ACCIAIO INOX 18/10
 Altezza: 80 cm
 STAINLESS STEEL 18/10
 Height: 80 cm



RIVESTIMENTO IN GOMMA NERA

Rivestimento ideato per attutire gli urti e i rumori, senza quindi danneggiare gli strumenti di lavoro come pale e palotti. Idoneo al contatto con gli alimenti.

Coating designed to absorb shocks and noises, without damaging work tools such as shovels and turning peels. Suitable for contact with food.





FIAMMA

La speciale forma evita l'incrociarsi dei manici, facilitandone la presa. 

The special shape avoids the crossing of the handles, facilitating their grip. 

TAPPETINO IN GOMMA

Polimero bianco rinforzato lavabile, resistente all'usura e a temperature fino ai 100°C 

Washable reinforced white polymer, resistant to wear and temperatures up to 100 °C 

CODICE	EAN	DIMENSIONE
2814/37	8014130240658	37x30x80 cm
2814/47	8014130241693	47x30x80 cm

Designed by
Itamar Harari



SUMO

La speciale forma evita l'incrociarsi dei manici, facilitandone la presa. 

The special shape avoids the crossing of the handles, facilitating their grip. 

CODICE	EAN	DIMENSIONE
2816/37	8014130241792	37x30x80 cm



Portapala a pavimento
e tappetino in gomma
Floor bracket and rubber mat

CODICE	EAN	DIMENSIONE
2810/40	8014130252576	40x20x12 cm
2810/50	8014130252590	50x20x12 cm

Porta pale Shovels holder

Stand Portapale Shovel Stand

CODICE	EAN	H	
2830/183	8014130257847	183 cm	150 cm
2830/213	8014130257854	213 cm	180 cm

Il colore della base in marmo potrebbe subire variazioni
The colour of the marble base could be different.

Supporto pala da muro INOX 18/10 Wall bracket stainless steel

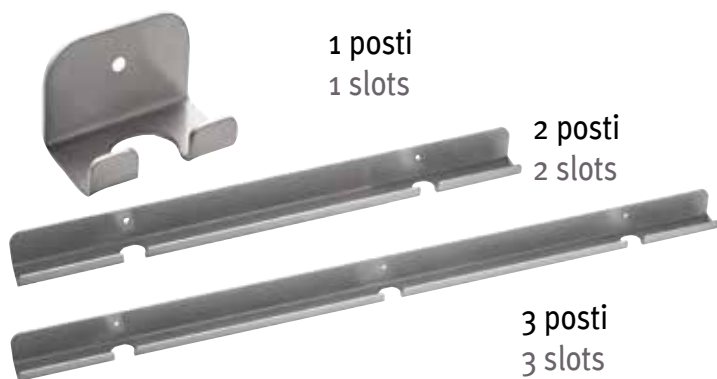

CODICE	EAN	DIMENSIONE
2800/1	8014130232769	4x6x3,5 cm
2800/2	8014130232783	4x50x3,5 cm
2800/3	8014130232806	4x85x3,5 cm



Supporto pala da muro INOX 18/10 con ganci laterali per accessori Wall bracket stainless steel with side hooks

CODICE	EAN	DIMENSIONE
2801	8014130254792	13x16,5x9,6 cm

Accessori pizzeria Pizza accessories

- Unica sul mercato con corpo stampato che le dona grande rigidità e durevolezza, realizzata con saldature in lega di **argento**.
- The only one on the market with a molded body that gives it great rigidity and durability, made with **silver welds**.



BECCO CON ROMPIGOCCIA

- Becco con rompigoccia realizzato tramite tubo martellato
- Spout with drip stop made with hammered tube



Olierona Chef INOX da 1 e 0,5 lt
Oil server stainless steel, 1 and 0,5 lt

CODICE	EAN	H	Lt
900	8014130008326	20,5 cm	1 lt
900/05	8014130008647	17 cm	0,5 lt



Mestolo pizza da 20 cl INOX 18/10
Tomato ladle 20 cl, stainless steel

CODICE	EAN	H	Ø
996	8014130009002	34 cm	9 cm





Cucchiaio per pizzaiolo
Spoon for pizza chef

CODICE	EAN	DIMENSIONE
997	8014130254754	30x7,5 cm

Accessori pizzeria Pizza accessories





Raschiatore in acciaio inox alta resistenza
Scraper in stainless steel high resistance

CODICE	EAN		
2769/8	8014130241358	12,5x8 cm	13 cm
2769/10	8014130241372	12,5x10 cm	13 cm
2769/12	8014130241594	13x12 cm	13 cm



Forbici tagliapizza
Pizza scissors

CODICE	EAN		
2775	8014130252699	13 cm	10x8 cm





Paletta rettangolare in acciaio inox alta resistenza
Rectangular pizza server in stainless steel high resistance

CODICE	EAN		
2767	8014130232905	22,5x7 cm	13 cm





Paletta rettangolare in acciaio inox alta resistenza
Rectangular pizza server in stainless steel high resistance

CODICE	EAN		
2768	8014130232929	8,5x15,5 cm	13 cm



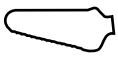

Paletta triangolare in acciaio inox alta resistenza
Triangular pizza server in stainless steel high resistance

CODICE	EAN		
2765	8014130232868	6,5x14 cm	13 cm



Spatola rigida in acciaio inox alta resistenza
Spatula in stainless steel high resistance

CODICE	EAN		
2771	8014130241617	15x7,7 cm	4x16,5 cm

Accessori pizzeria Pizza accessories



Rotella tagliapizza ergonomica
Pizza wheel cutter ergonomic

CODICE	EAN	DIMENSIONE	→ ←
2773	8014130244137	24xø10,5 cm	1 mm
2773/R	lama in acciaio inossidabile alta qualità		



Rotella tagliapizza Luxury
Pizza wheel cutter Luxury

CODICE	EAN	DIMENSIONE	→ ←
2774	8014130252675	24xø10,5 cm	1 mm
2774/R	lama in acciaio temprato		



Rotella tagliapizza
Pizza wheel cutter

CODICE	EAN	DIMENSIONE	→ ←
2772	8014130241396	20xø10cm	0,7 mm



Retina rettangolare in alluminio
Rectangular pizza screen

CODICE	EAN	DIMENSIONE
7703020	8014130244076	30x20 cm
7704028	8014130241532	40x28 cm
7705530	8014130241556	55x30 cm
7706040	8014130241570	60x40 cm



Retina tonda in alluminio
Round pizza screen

CODICE	EAN	Ø
77028	8014130243970	28 cm
77030	8014130243994	30 cm
77033	8014130244014	33 cm
77036	8014130241495	36 cm
77040	8014130244038	40 cm
77045	8014130241518	45 cm
77050	8014130244052	50 cm

Accessori pizzeria Pizza accessories



Piatto spicchio in alluminio anodizzato con manico
 Pizza tray in anodized aluminum with handle

CODICE	EAN	Ø
942/30	8014130252613	30 cm
942/40	8014130252637	40 cm
942/50	8014130252651	50 cm



Cacciapizza in alluminio spazzolato con manico
 Pizza tray in aluminum with handle

CODICE	EAN	Ø
944/31	8014130255430	31 cm
944/36	8014130255454	36 cm
944/41	8014130255478	41 cm



Cassetta pizza
 Pizza box

CODICE	EAN	DIMENSIONE	H
7756040-7	8014130241730	60x40cm	7cm
7756040-10	8014130241754	60x40cm	10cm

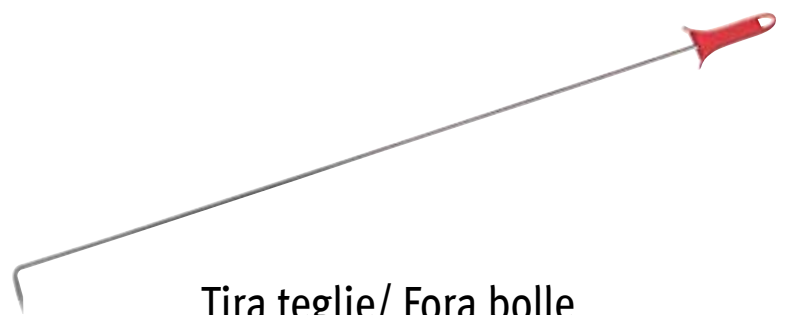

Tira teglie/ Fora bolle
 Pizza Bubble Popper

CODICE	EAN	DIMENSIONE
2777	8014130254372	90 cm



Coperchio copricassetta
 Pizza box cover

CODICE	EAN	DIMENSIONE
7756040-CO	8014130241778	60x40cm



Pinza per teglie
 Tong for baking trays

CODICE	EAN	DIMENSIONE
2778	8014130254778	23x7x5,5 cm

Accessori delivery Delivery accessories

Valigetta Professionale

Composto da Composed of:

- 1 x Pala pizza quadra forata smontabile Linea Anodizzata Dura 33x33 cm, manico 120 cm
 - 1 x Pala forata ø 18 cm, smontabile, manico scorrevole 150 cm
 - 1 x Rotella tagliapizza
 - 1 x Forbici tagliapizza
 - 1 x Cucchiaino da pizzaiolo
 - 1 x Raschiatore + Spatola
- 1 x Perforated Square pizza shovel hard anodized 33x33 cm, detachable handle 120 cm
 - 1 x Perforated round pizza shovel SS ø18 cm, with sliding detachable handle 150 cm
 - 1 x Pizza wheel cutter
 - 1 x Pizza scissors
 - 1 x Spoon for pizza chef
 - 1 x Scraper + Spatula

CODICE **EAN** **DIMENSIONE**

VAL2779/AN DURA 8014130257342 65x47x6 cm



Valigetta Professionale

Composto da Composed of:

- 1 x Pala pizza quadra forata smontabile Linea Tulip 33x33 cm, manico 120 cm
 - 1 x Pala forata ø18 cm, smontabile, manico scorrevole 150 cm
 - 1 x Rotella tagliapizza
 - 1 x Forbici tagliapizza
 - 1 x Cucchiaino da pizzaiolo
 - 1 x Raschiatore + Spatola
- 1 x Perforated Square pizza shovel Tulip 33x33 cm, detachable handle 120 cm
 - 1 x Perforated round pizza shovel SS ø18 cm, with sliding detachable handle 150 cm
 - 1 x Pizza wheel cutter
 - 1 x Pizza scissors
 - 1 x Spoon for pizza chef
 - 1 x Scraper + Spatula

CODICE **EAN** **DIMENSIONE**

VAL2779/TULIP 8014130257335 65x47x6 cm



Valigetta Professionale

Composto da Composed of:

- 1 x Pala pizza forata smontabile Linea 60° Anniversario 33x33 cm, manico 120 cm
 - 1 x Pala forata ø18 cm, smontabile, manico scorrevole 150 cm
 - 1 x Rotella tagliapizza
 - 1 x Forbici tagliapizza
 - 1 x Cucchiaino da pizzaiolo
 - 1 x Raschiatore + Spatola
- 1 x Perforated Square pizza shovel 60th Anniversary 33x33 cm, detachable handle 120 cm
 - 1 x Perforated round pizza shovel SS ø18 cm, with sliding detachable handle 150 cm
 - 1 x Pizza wheel cutter
 - 1 x Pizza scissors
 - 1 x Spoon for pizza chef
 - 1 x Scraper + Spatula

CODICE **EAN** **DIMENSIONE**

VAL2779/60° 8014130257328 65x47x6 cm



Accessori delivery Delivery accessories

DIMENSIONI:
35X35X32 cm



Zaino termico per pizza,
9 cartoni, Pol600
Thermal backpack for pizza,
9 pizza boxes, Pol600

CODICE	EAN	DIMENSIONE
BZP323535	8014130254990	35x35x32 cm

DIMENSIONI
35X35X45 cm

Zaino termico per pizza,
12 cartoni, Pol600
Thermal backpack for pizza,
12 pizza boxes, Pol600



CODICE	EAN	DIMENSIONE
BZP453535	8014130255010	35x35x45 cm

Accessori delivery

Delivery accessories *Pol600*

Borsa termica per pizza 4/5 cartoni, Pol600
Thermal pizza bag, 4/5 pizza boxes, Pol600

CODICE	EAN	DIMENSIONE
BP3535	8014130254914	35x35x22 cm



Borsa termica per pizza 4/5 cartoni, Pol600
Thermal pizza bag, 4/5 pizza boxes, Pol600

CODICE	EAN	DIMENSIONE
BP4242	8014130254938	42x42x22 cm



Borsa termica per pizza 4/5 cartoni, Pol600
Thermal pizza bag, 4/5 pizza boxes, Pol600

CODICE	EAN	DIMENSIONE
BP4747	8014130254952	47x47x22 cm



Borsa termica per pizza mezzo metro, 4/5 cartoni Pol600
Thermal pizza bag half meter, 4/5 pizza boxes Pol600

CODICE	EAN	DIMENSIONE
BP6042	8014130254976	60x42x22 cm



Accessori delivery

Delivery accessories *Nylon*



Borsa termica per pizza 4/5 cartoni, Nylon
Thermal pizza bag, 4/5 pizza boxes, Nylon

CODICE	EAN	DIMENSIONE
BN3535	8014130254839	35x35x22 cm



Borsa termica per pizza 4/5 cartoni, Nylon
Thermal pizza bag, 4/5 pizza boxes, Nylon

CODICE	EAN	DIMENSIONE
BN4242	8014130254853	42x42x22 cm



Borsa termica per pizza 4/5 cartoni, Nylon
Thermal pizza bag, 4/5 pizza boxes, Nylon

CODICE	EAN	DIMENSIONE
BN4747	8014130254877	47x47x22 cm



Borsa termica per pizza mezzo metro, 4/5 cartoni Nylon
Thermal pizza bag half meter, 4/5 pizza boxes Nylon

CODICE	EAN	DIMENSIONE
BN6042	8014130254891	60x42x22 cm





Setacci



Sieves:

- Setacci Farina
Flour sieves
- Setacci Pane
Bread sieves
- Setacci Pesce
Fish sieves
- Setacci Pasticceria / Granella
Confectionary sieves

Setacci professionali

Realizzati interamente in acciaio inox AISI 304 e costruiti secondo i più alti standard di lavorazione, si distinguono e riconoscono con facilità per la solidità della struttura, la tensione della rete e la cura del dettaglio. Disponibili in 23 versioni, 6 misure diverse, dal diametro da 20cm a 45cm e 4 differenti maglie, sono ideati per l'utilizzo intensivo. Mantengono inalterata qualità e stabilità nel tempo grazie alle loro caratteristiche sono destinati ai professionisti più esigenti.

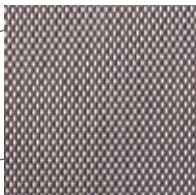
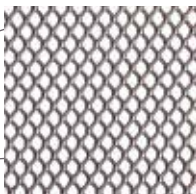
Setacci

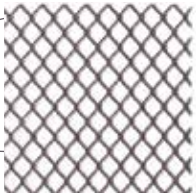
	Rhombus Passage 0,5 x 0,5 mm
scala 1:1	Setaccio Farina Flour Sieve
	Rhombus Passage 1 x 1,5 mm
scala 1:1	Setaccio Pane Bread Sieve
	Square Passage 6 x 6 mm
scala 1:1	Setaccio Pesce Fish Sieve
	Square Passage 2,2 x 2,2 mm
scala 1:1	Setaccio Pasticceria Confectionary Sieve

MADE IN ITALY



Professional Sieves

Entirely made of AISI 304 stainless steel and built according to the highest standards of workmanship, they are easily distinguished and recognized by the solidity of the structure, the tension of the net and the attention to detail. Available in 23 versions, 6 different sizes, from 20cm to 45cm diameter and 4 different meshes, they are designed for intensive use and maintain quality and stability over time, thanks to their characteristics they are intended for the most demanding professionals.

Setacci



Asciugapasta

Asciugapasta INOX 18/10 con piedini

Drying tray with feet stainless steel

CODICE	EAN	H	DIMENSIONE
80015	8014130008104	6 cm	60x40 cm

Asciugapasta INOX 18/10 senza piedini

Drying tray without feet stainless steel

CODICE	EAN	H	DIMENSIONE
80015S	8014130008111	6 cm	60x40 cm



Setacci Farina Flour Sieves

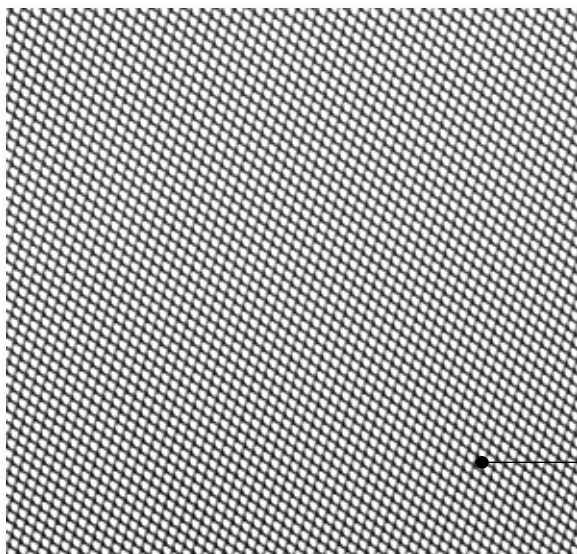

scala 2:1

- Realizzato in acciaio inox
- Made of Stainless Steel

Rhombus
Passage
0,5 x 0,5 mm

Altezza bordatura
Border height
10 cm (5,8cm - 4cm)



Setaccio professionale per farina
Professional flour sieve

CODICE	EAN	H	Ø
80006F	8014130007725	10 cm	20 cm
80008F	8014130007701	10 cm	25 cm
80010F	8014130003390	10 cm	30 cm
80012F	8014130003406	10 cm	35 cm
80014F	8014130240474	10 cm	40 cm
80016F	8014130240511	10 cm	45 cm

Setacci Pane Bread Sieves

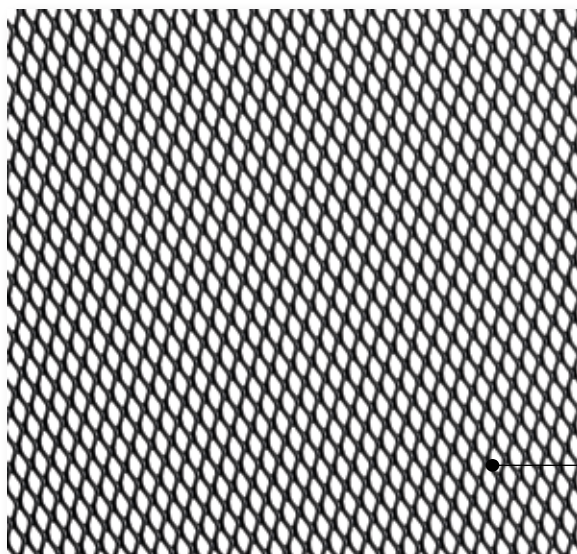

scala 2:1

- Realizzato in acciaio inox
- Made of Stainless Steel

Rhombus
Passage
1 x 1,5 mm

Altezza bordatura
Border height
10 cm (5,8cm - 4cm)



Setaccio professionale per pane
Professional bread sieve

CODICE	EAN	H	Ø
80006	8014130007749	10 cm	20 cm
80008	8014130007688	10 cm	25 cm
80010	8014130003451	10 cm	30 cm
80012	8014130003437	10 cm	35 cm
80014	8014130240535	10 cm	40 cm
80016	8014130240573	10 cm	45 cm

Setacci Pesce Fish Sieves

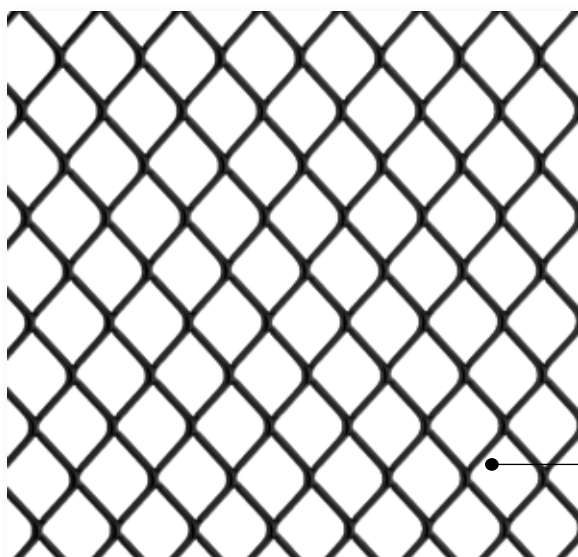

scala 2:1

- Realizzato in acciaio inox
- Made of Stainless Steel

Square
Passage
6 x 6 mm

Altezza bordatura
Border height
10 cm (5,8cm - 4cm)

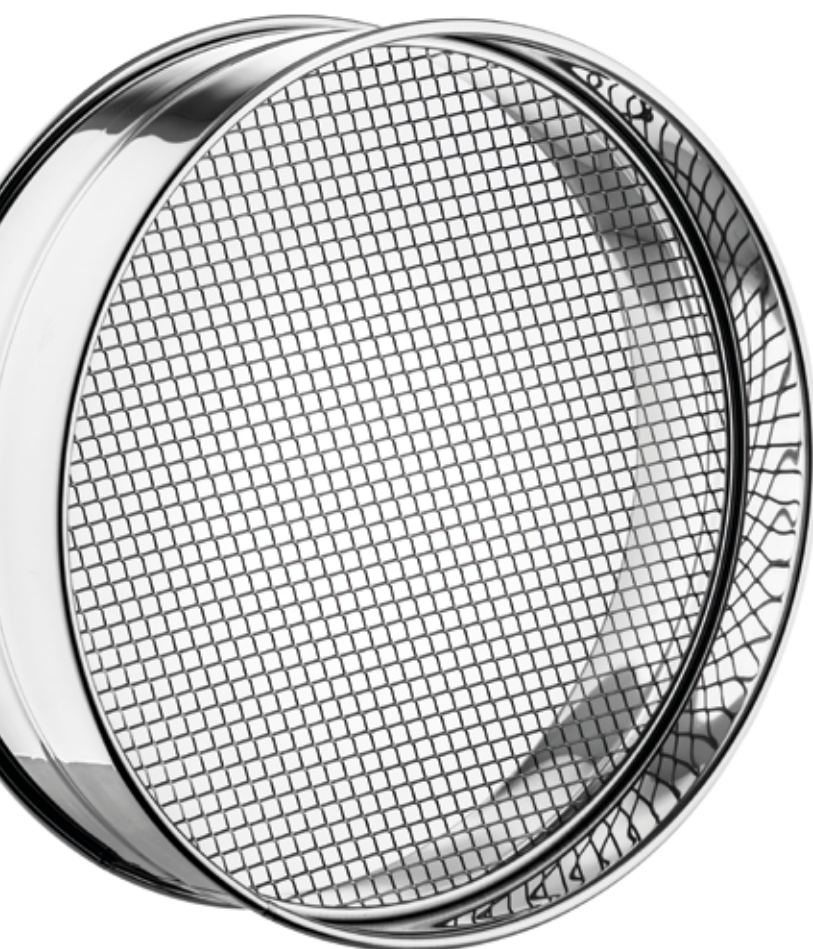
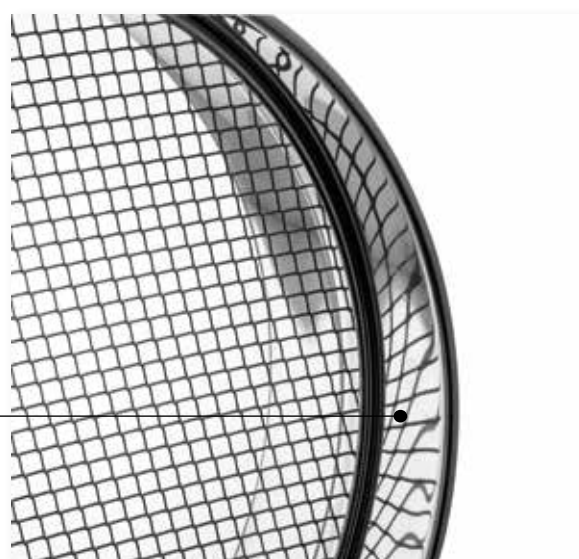

Setaccio professionale per pesce
Professional fish sieve

CODICE	EAN	H	Ø
80008P	8014130008432	10 cm	25 cm
80010P	8014130003383	10 cm	30 cm
80012P	8014130003352	10 cm	35 cm
80014P	8014130240498	10 cm	40 cm
80016P	8014130240610	10 cm	45 cm

Setacci Pasticceria Granella

Confectionary Sieves

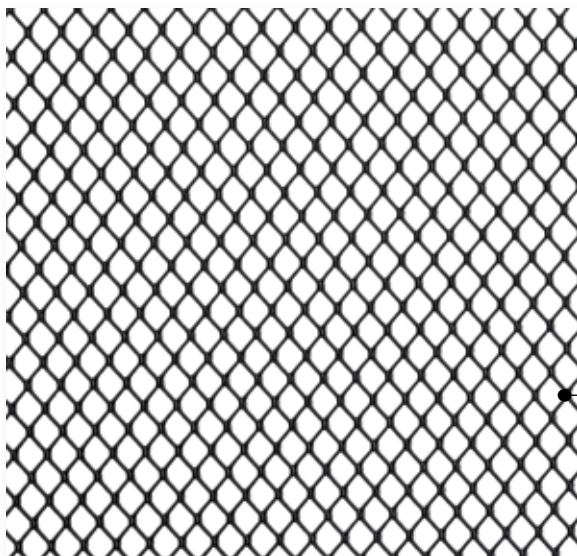

scala 2:1

- Realizzato in acciaio inox
- Made of Stainless Steel

Square
Passage
2,2 x 2,2 mm

Altezza bordatura
Border height
10 cm (5,8cm - 4cm)



Setaccio professionale
per pasticceria/granella
Professional confectionary sieve

CODICE	EAN	H	Ø
80006G	8014130008401	10 cm	20 cm
80008G	8014130008425	10 cm	25 cm
80010G	8014130008277	10 cm	30 cm
80012G	8014130008005	10 cm	35 cm
80014G	8014130240559	10 cm	40 cm
80016G	8014130240597	10 cm	45 cm





Teglie da forno

Baking trays:

- Teglie in lamiera blu
Blue metal sheet pans
- Teglie alluminate
Aluminized metal sheet pans
- Teglie in alluminio
Aluminum pans

Teglie da forno Baking pans

 Cerutti Inox offre una vasta gamma di teglie per le preparazioni di pizze, dolci e non solo. Rettangolari e tonde, di varie misure e materiali, queste teglie sono pensate per incontrare tutte le esigenze. Disponibili in lamiera blu, alluminate e in alluminio, ogni teglia grazie alle sue caratteristiche aiuterà l'utilizzatore ad ottenere i migliori risultati di cottura.

 Cerutti Inox offers a wide range of trays for the preparation of pizzas, pastries and more. Rectangular and round, of various sizes and materials, these trays are designed to meet all needs. Available material: blue metal sheet, aluminized, aluminum. Each pan thanks to its characteristics will help the user to obtain the best cooking results.

ALLUMINATO

 Specifiche per l'utilizzo in pasticcerie, pizzerie e panetterie realizzate in **lamiera alluminata**, sono ideali per le cotture in forno fino a 295 °C. Le teglie in lamiera alluminata sono composte dal 90% di alluminio e il 10% di silicio e questo le rende molto resistenti all'ossidazione, pertanto sono anche consigliate per l'utilizzo in celle di lievitazione e surgelazione.

 *Specific for use in pastry shops, pizzerias and bakeries made of aluminized sheet metal, they are ideal for cooking in the oven up to 295 ° C. The aluminized sheet pans are composed of 90% aluminum and 10% silicon and this makes them very resistant to oxidation, therefore they are also recommended for use in leavening and freezing cells.*





FERRO BLU

 Il **Ferro Blu** è il materiale ideale per la cottura di pizze e focacce, realizzato con semplice lamiera di ferro saldata, permette di cuocere perfettamente ogni impasto, garantendo ottimali risultati di cottura e durezza nel tempo.

 *Blue Metal Sheet is the ideal material for cooking pizzas and focaccias, made with simple welded iron sheet, it allows you to cook every dough perfectly, ensuring optimal cooking results and durability over time.*

ALLUMINIO

 Grazie alle molteplici qualità dell' **Alluminio** queste teglie sono molto versatili, prima fra tutte un'ottima conducibilità che consente al calore di diffondersi uniformemente su tutta la superficie, sono leggere e maneggevoli, ma anche resistenti agli urti e alle abrasioni. Non necessitano di particolare manutenzione.

 *Thanks to the multiple qualities of Aluminum these trays are very versatile, first of all an excellent conductivity that allows the heat to spread evenly over the entire surface, they are light and easy to handle, but also resistant to shocks and abrasions. They do not require particular maintenance.*



MADE IN ITALY

Lamiera blu Blue Metal Sheet

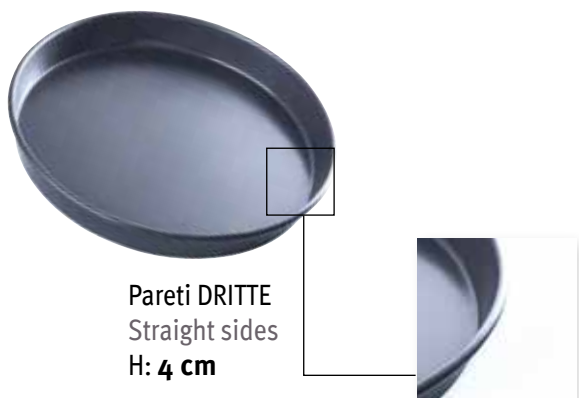

Teglia tonda in lamiera blu con bordo alto

Round blue metal sheet pan, high edge

CODICE	EAN	DIMENSIONE
764/1604	8014130243093	ø16x4 cm
764/1804	8014130243116	ø18x4 cm
764/2004	8014130243130	ø20x4 cm
764/2204	8014130243154	ø22x4 cm
764/2404	8014130243178	ø24x4 cm
764/2604	8014130243192	ø26x4 cm
764/2804	8014130243215	ø28x4 cm
764/3004	8014130243239	ø30x4 cm
764/3204	8014130240733	ø32x4 cm
764/3604	8014130243253	ø36x4 cm
764/4004	8014130243277	ø40x4 cm
764/4504	8014130243291	ø45x4 cm
764/5004	8014130243314	ø50x4 cm
764/6004	8014130243352	ø60x4 cm

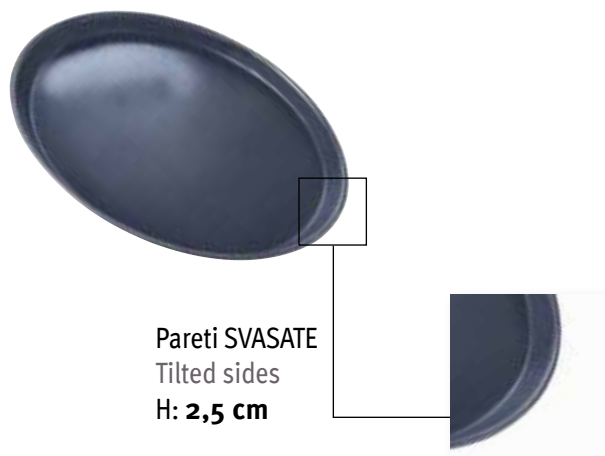

Teglia tonda in lamiera blu con bordo basso

Round blue metal sheet pan, low edge

CODICE	EAN	DIMENSIONE
762/1425	8014130242973	ø14x2,5 cm
762/1625	8014130243017	ø16x2,5 cm
762/1825	8014130243031	ø18x2,5 cm
762/2025	8014130241136	ø20x2,5 cm
762/2225	8014130240979	ø22x2,5 cm
762/2425	8014130241013	ø24x2,5 cm
762/2625	8014130241037	ø26x2,5 cm
762/2825	8014130241051	ø28x2,5 cm
762/3025	8014130241075	ø30x2,5 cm
762/3225	8014130241150	ø32x2,5 cm
762/3425	8014130241099	ø34x2,5 cm
762/3625	8014130241112	ø36x2,5 cm
762/4025	8014130243055	ø40x2,5 cm
762/5025	8014130243079	ø50x2,5 cm

Lamiera blu Blue Metal Sheet



Pareti SVASATE
Tilted sides
H: 3 cm

Teglia rettangolare in lamiera blu
Rectangular blue metal sheet pan

CODICE	EAN	DIMENSIONE
760302303	8014130242713	30x23x3 cm
760352803	8014130242737	35x28x3 cm
760403003	8014130242799	40x30x3 cm
760453503	8014130242812	45x35x3 cm
760503503	8014130242836	50x35x3 cm
760604003	8014130241419	60x40x3 cm
760654503	8014130242874	65x45x3 cm



Teglia rettangolare in lamiera blu
pareti dritte, base rinforzata X
Rectangular blue metal sheet tray, with
straight sides, reinforced X base

CODICE	EAN	DIMENSIONE
760604002X	8014130257908	60X40X2h



Teglia rettangolare in lamiera blu pareti
svasate, base rinforzata X
Rectangular blue metal sheet tray with tilted
sides, reinforced X base

CODICE	EAN	DIMENSIONE
760604003X	8014130257939	60X40X3h



Pareti DRITTE
Straight sides
H: 2 cm

Teglia rettangolare in lamiera blu
Rectangular blue metal sheet pan

CODICE	EAN	DIMENSIONE
760604002	8014130242898	60x40x2 cm
760602002	8014130242935	60x20x2 cm

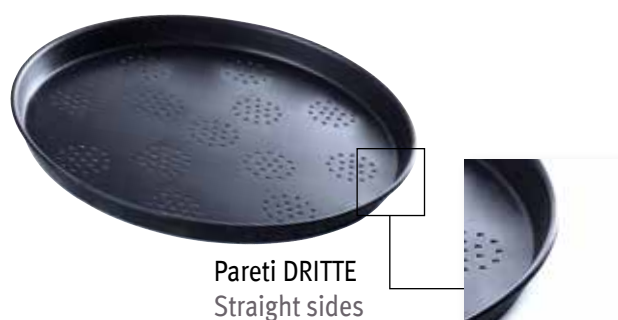

Pareti DRITTE
Straight sides
H: 2,5 cm

Teglia tonda in lamiera blu forata
Perforated round blue metal sheet pan

CODICE	EAN	DIMENSIONE
762F/3225	8014130241457	ø32x2,5 cm
762F/5025	8014130241471	ø50x2,5 cm

Alluminate Aluminized

Teglia rettangolare in ferro alluminato
pareti dritte, base rinforzata X
Rectangular blue metal sheet tray, with
straight sides, reinforced X base



CODICE	EAN	DIMENSIONE
--------	-----	------------

760AA604002X	8014130258011	60x40x2 cm
--------------	---------------	------------

Teglia rettangolare in ferro alluminato
pareti svasate, base rinforzata X
Rectangular blue metal sheet tray, with
tilted sides, reinforced X base

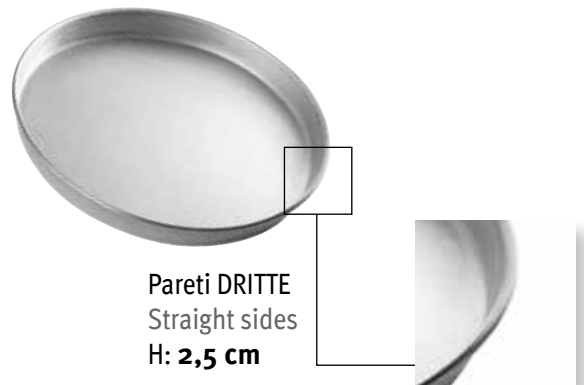

CODICE	EAN	DIMENSIONE
--------	-----	------------

760AA604003X	8014130258004	60x40x3 cm
--------------	---------------	------------

Teglia tonda alluminata
Round aluminized metal sheet pan

CODICE	EAN	DIMENSIONE
--------	-----	------------

762AA/2025	8014130243512	ø20x2,5 cm
------------	---------------	------------

762AA/2425	8014130243536	ø24x2,5 cm
------------	---------------	------------

762AA/2825	8014130243550	ø28x2,5 cm
------------	---------------	------------

762AA/3225	8014130243574	ø32x2,5 cm
------------	---------------	------------

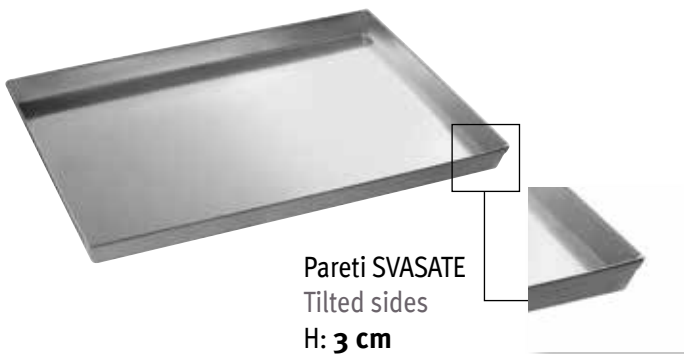

Teglia rettangolare alluminata
Rectangular aluminized metal sheet pan

CODICE	EAN	DIMENSIONE
--------	-----	------------

760AA30233	8014130255812	30x23x3 cm
------------	---------------	------------

760AA35283	8014130255553	35x28x3 cm
------------	---------------	------------

760AA40303	8014130255539	40x30x3 cm
------------	---------------	------------

760AA45353	8014130255515	45x35x3 cm
------------	---------------	------------

760AA50353	8014130255492	50x35x3 cm
------------	---------------	------------

760AA60403	8014130241433	60x40x3 cm
------------	---------------	------------

Teglia rettangolare alluminata
Rectangular aluminized metal sheet pan

CODICE	EAN	DIMENSIONE
--------	-----	------------

760AA60402	8014130242652	60x40x2 cm
------------	---------------	------------

760AA60202	8014130255850	60x20x2 cm
------------	---------------	------------

Alluminio Aluminum

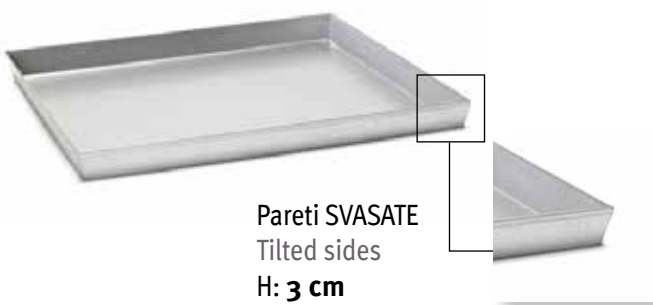

Teglia rettangolare in alluminio
Rectangular aluminum pan

CODICE	EAN	DIMENSIONE
760AL35283	8014130255058	35x28x3 cm
760AL40303	8014130242591	40x30x3 cm
760AL45353	8014130255034	45x35x3 cm
760AL50353	8014130242577	50x35x3 cm
760AL60403	8014130241679	60x40x3 cm



Teglia rettangolare in alluminio
Rectangular aluminum pan

CODICE	EAN	DIMENSIONE
760AL40302	8014130242638	40x30x2 cm
760AL50352	8014130242614	50x35x2 cm
760AL60402	8014130241655	60x40x2 cm



Teglia tonda alta in alluminio
Round high aluminum pan

CODICE	EAN	DIMENSIONE
763A2205	8014130255676	ø22x5 cm
763A2405	8014130255690	ø24x5 cm
763A2605	8014130255713	ø26x5 cm



Teglia tonda alta in alluminio
Round high aluminum pan

CODICE	EAN	DIMENSIONE
763A2806	8014130255737	ø28x6 cm
763A3006	8014130255751	ø30x6 cm
763A3206	8014130255775	ø32x6 cm

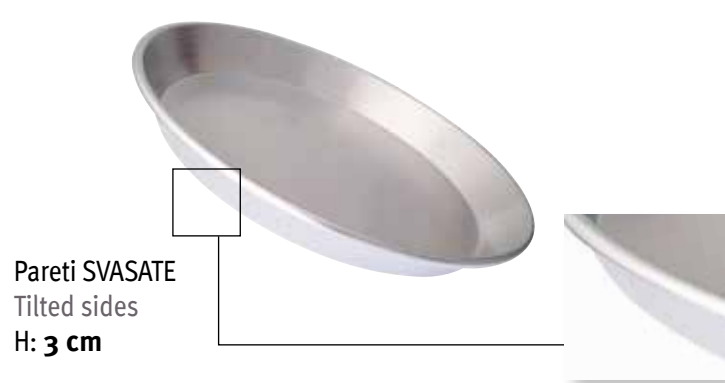

Teglia tonda bassa in alluminio
Round low aluminum pan

CODICE	EAN	DIMENSIONE
763A2003	8014130255577	ø20x3 cm
763A2403	8014130255591	ø24x3 cm
763A2803	8014130255614	ø28x3 cm
763A3203	8014130255638	ø32x3 cm
763A3603	8014130255652	ø36x3 cm

Alluminio Aluminum



Vassoio rettangolare microforato in alluminio
Microperforated rectangular aluminum tray

CODICE	EAN	DIMENSIONE
765403010F	8014130257991	40x30x1,2 cm
765604010F	8014130255935	60x40x1,2 cm





Accessori ristorazione

Catering accessories:

- Accessori tavola e cucina
Table and kitchen accessories
- Porta tacos
Tacos holder
- Coppe macedonia
Fruit salad cups
- Formaggiere
Cheese bowls
- Accessori pasticceria
Pastry accessories
- Set condimenti
Condiments set

Accessori ristorazione

 Indispensabili per le sale di ogni ristorante e bar. Cerutti Inox offre un'intera gamma di accessori utili ad ogni locale pubblico, come set per condimenti, formaggiere, porta bustine, porta tovaglioli e molto altro. Il tutto realizzato in Italia con i migliori materiali e nel massimo rispetto delle certificazioni ISO 9001- ISO 14001 e MOCA che garantiscono qualità, rispetto per l'ambiente e la certificazione dei prodotti destinati al contatto con gli alimenti.

Accessori tavola e cucina Table and kitchen accessories



Segnaposto riservato, inox
Reservation table stand, stainless steel



Segnaposto numerato, inox
Number table stand, stainless steel

CODICE	EAN	DIMENSIONE
31AN	8014130245097	4x6,5x3,5 cm

CODICE	EAN	DIMENSIONE
31N	8014130245110	4x6,5x3,5 cm



Posacenere quadro, inox
Square ashtray, stainless steel



Gancio appendiborsetta, inox **MIMI'**
Handbag hook, stainless steel

CODICE	EAN	DIMENSIONE
10	8014130003970	10x10x1,5 cm

CODICE	EAN	DIMENSIONE
1015	8014130009309	12x5x1,2 cm



Posacenere tondo, inox
Round ashtray, stainless steel



Copritazze, inox
Cup cover, stainless steel

CODICE	EAN	DIMENSIONE
11	8014130002959	Ø10x3,5 cm

CODICE	EAN	DIMENSIONE
111/75	8014130002508	Ø7,5 cm
111/85	8014130002539	Ø8,5 cm
111/10	8014130002553	Ø10 cm



Essential for the halls of every restaurant and bar. Cerutti Inox offers a whole range of accessories useful for any public place, such as condiment sets, cheese bowls, sachet holders, napkin holders and much more. All made in Italy with the best materials and with the utmost respect for ISO 9001- ISO 14001 and MOCA certifications which guarantee quality, respect for the environment and certification of the product in contact with food.

Accessori tavola e cucina Table and kitchen accessories



Sottobicchiere rigato, inox

Coaster with ornaments, stainless steel

CODICE	EAN	DIMENSIONE
114/9R	8014130003741	Ø9 cm
114/11R	8014130003765	Ø11 cm
114/14R	8014130003789	Ø14 cm



Sottobicchiere liscio, inox

Coaster without ornaments, stainless steel

CODICE	EAN	DIMENSIONE
114/9L	8014130003734	Ø9 cm
114/11L	8014130003758	Ø11 cm
114/14L	8014130003796	Ø14 cm



Ceneriera, inox

Ashtray, stainless steel

CODICE	EAN	DIMENSIONE
13	8014130004557	Ø14x5,5 cm



Campanello da tavolo, inox

Hand bell, stainless steel

CODICE	EAN	DIMENSIONE
55	8014130004755	Ø5x9 cm



Cover per dispenser fazzoletti da tavolo

Cover for napkins dispenser

CODICE	EAN	DIMENSIONE
670	8014130255959	23,5x12,3x5,5 cm



Fermatovaglia, inox

Table cloth holder, stainless steel

CODICE	EAN	DIMENSIONE
4	8014130004304	4,5x4,5x1,5 cm

Accessori tavola e cucina

Table and kitchen accessories

Designed by
Itamar Harari



Spillone, inox
Receipt holder, stainless steel

CODICE	EAN	DIMENSIONE
505	8014130233629	Ø10,5x18,5 cm



Vassoietto portaposate
Cutlery tray

CODICE	EAN	DIMENSIONE
75	8014130253139	27x12 cm



Stampo crème caramel, inox
Crème caramel tin, stainless steel

CODICE	EAN	DIMENSIONE
106A	8014130002355	Ø7x6,5 cm - 15cl
106B	8014130002300	Ø7x5 cm - 10 cl



Portacucchiaini in acciaio inox 18/10
Spoon holder made of SS 18/10

CODICE	EAN	DIMENSIONE
215/7	8014130004335	Ø7x7,5 cm



Raccoglibriciole in inox, nylon, alluminio e setole
Crumb picker, SS, nylon, aluminum and bristles

CODICE	EAN	DIMENSIONE
513	8014130003154	7x15x14,5 cm



Porta Tacos in acciaio inox 18/10
Tacos holder in stainless steel 18/10

CODICE	EAN	DIMENSIONE
18329	8014130258844	13,5x5,5x3,5 cm



Porta Tacos Onda in acciaio inox 18/10
Wavy tacos holder in stainless steel 18/10

CODICE	EAN	DIMENSIONE
18330	8014130258851	14,5x6x3,5 cm

Accessori tavola e cucina

Table and kitchen accessories



Personalizzabile
Customizable

Pinza per affettato, inox
Ham tongs, stainless steel

CODICE	EAN	DIMENSIONE
105	8014130001709	4,5x10x5 cm



Mestolino con fori, inox
Ladle with holes, stainless steel

CODICE	EAN	DIMENSIONE
20	8014130004625	Ø3,5x21,5 cm
20/A	8014130004632	Ø4x21,5 cm
20/BS	8014130004656	Ø4,5x21,5 cm



Mestolino senza fori, inox
Ladle without holes, stainless steel

CODICE	EAN	DIMENSIONE
20/S	8014130004618	Ø3,5x21,5 cm
20/4S	8014130004601	Ø4x21,5 cm
20/B	8014130004649	Ø4,5x21,5 cm



Mestolino con beccuccio, inox
Ladle with spout, stainless steel

CODICE	EAN	DIMENSIONE
20/G	801413004663	Ø4x21,5 cm

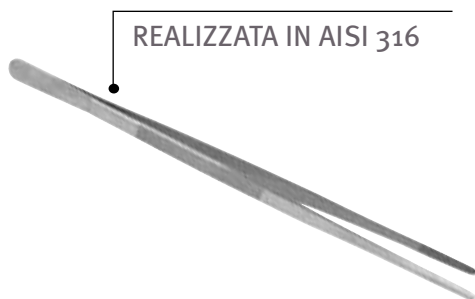

REALIZZATA IN AISI 316

Pinze Chef Chef Tongs

CODICE	EAN	DIMENSIONE
080370/30	8014130251739	30 cm
080370/35	8014130251753	35 cm

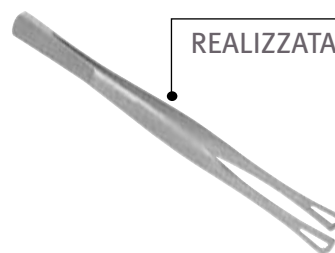

REALIZZATA IN AISI 316

Pinza spinapesce
Tongs for herringbones

CODICE	EAN	DIMENSIONE
80380	8014130251777	15 cm

Coppe macedonia Fruit salad cups



Coppa macedonia inox
Fruit salad bowl stainless

CODICE	EAN	DIMENSIONE
76/10	8014130003505	Ø10 cm
76/12	8014130003529	Ø12 cm



Coppa macedonia inox
Fruit salad bowl stainless steel

CODICE	EAN	DIMENSIONE
140/10	8014130003253	Ø10 cm
140/12	8014130003284	Ø12 cm



Coppa macedonia inox
Fruit salad bowl stainless

CODICE	EAN	DIMENSIONE
657/10	8014130011630	Ø10 cm
657/12	8014130011647	Ø12 cm



Coppa macedonia inox
Fruit salad bowl stainless steel

CODICE	EAN	DIMENSIONE
662/10	8014130011852	Ø10 cm
662/12	8014130011869	Ø12 cm

Formaggiere Cheese bowls



Formaggiere acciaio inox
Parmesan cheese cellar stainless steel

CODICE	EAN	DIMENSIONE
185	8014130003857	Ø8,5x7,5 cm



Formaggiere inox e vetro **STRESA**
Parmesan cheese cellar, stainless steel and glass

CODICE	EAN	DIMENSIONE
655	8014130001655	Ø9,5x8 cm



Formaggiere inox e vetro
Parmesan cheese cellar, stainless steel and glass

CODICE	EAN	DIMENSIONE
8L	8014130001105	Ø8,8x7,5 cm

Accessori pasticceria Pastry accessories

Disco sottotorta in alluminio
Aluminum cake board

CODICE	EAN	DIMENSIONE
990/14	8014130254532	Ø14 cm
990/16	8014130253153	Ø16 cm
990/18	8014130253177	Ø18 cm
990/20	8014130253191	Ø20 cm
990/22	8014130253214	Ø22 cm
990/24	8014130253238	Ø24 cm
990/26	8014130253252	Ø26 cm
990/28	8014130253276	Ø28 cm
990/30	8014130253290	Ø30 cm
990/32	8014130253313	Ø32 cm
990/34	8014130254556	Ø34 cm
990/36	8014130254570	Ø36 cm
990/38	8014130254594	Ø38 cm
990/40	8014130254617	Ø40 cm
990/46	8014130254631	Ø46 cm
990/50	8014130254655	Ø50 cm
990/60	8014130254679	Ø60 cm



Alzata portatorta inox e vetro
Cake stand stainless steel and glass

CODICE	EAN	DIMENSIONE
991/21	8014130011661	Ø21x10 cm
991/26	8014130011678	Ø26x10 cm
991/31	8014130011685	Ø31x10 cm
991/33	8014130132700	Ø33x10 cm
991/40	8014130011692	Ø40x10 cm

Set condimenti Condiments set



5 pz.

Olio, aceto, sale, pepe e stecchi **STRESA**
Condiments set 5 pz.

CODICE	EAN	DIMENSIONE
650	8014130001600	19x16,5x10 cm

IN ESAURIMENTO



3 pz.

Sale, pepe e stecchi **STRESA**
Condiments set 3 pz.

CODICE	EAN	DIMENSIONE
652	8014130001907	12,5x8x7 cm



4 pz.

Olio, aceto, sale e pepe **STRESA**
Condiments set 4 pz.

CODICE	EAN	DIMENSIONE
650/4	8014130001617	19x13x12 cm

IN ESAURIMENTO



2 pz.

Sale e pepe **STRESA**
Condiments set 2 pz.

CODICE	EAN	DIMENSIONE
652/2	8014130007558	12,5x8x4,5 cm



2 pz.

Olio e aceto **STRESA**
Condiments set 2 pz.

CODICE	EAN	DIMENSIONE
651	8014130001853	19x13,5x7 cm



Sale, pepe o stecchi **STRESA**
Salt-pepper, toothpick holder

CODICE	EAN	DIMENSIONE
660	8014130006605	Ø3,5x9 cm

Set condimenti Condiments set



2 pz.

Sale e pepe **CUSIO**
Condiments set 2 pz.

CODICE	EAN	DIMENSIONE
602/2	8014130007572	11,5x9x4 cm



Spargisale, pepe o stecchi **CUSIO**
Salt-pepper, toothpick holder

CODICE	EAN	DIMENSIONE
610	8014130001501	Ø3,5x8 cm



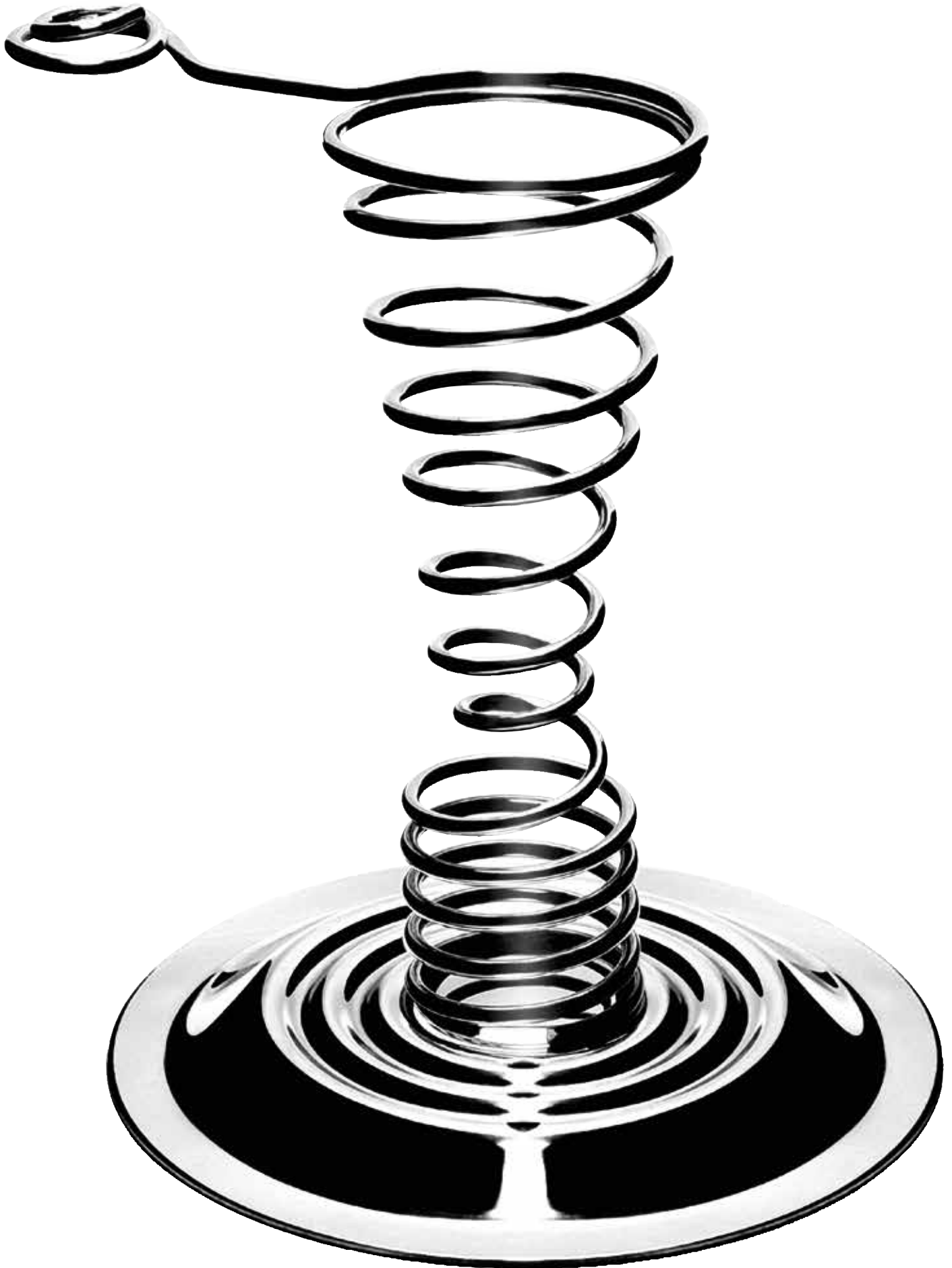

Accessori gelateria

Ice cream shops accessories:

- Servicono
Ice cream server
- Spatole gelato
Ice cream spatula
- Piatto per cassata
Cassata dish

Accessori gelateria

 Spatole, piattini e servicono sono gli utensili indispensabili in ogni gelateria per offrire un servizio completo e accurato. Realizzati interamente in acciaio inossidabile sono inoltre di facile pulizia, garanzia di qualità e resistenza nel tempo.



ACCIAIO INOX 18/10

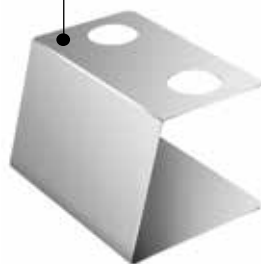

Stresa

Servicono gelato a 2 posti, inox
Ice cream server 2 slots, stainless steel

CODICE	EAN	DIMENSIONE
669/2	8014130136708	10x13x9,5 cm

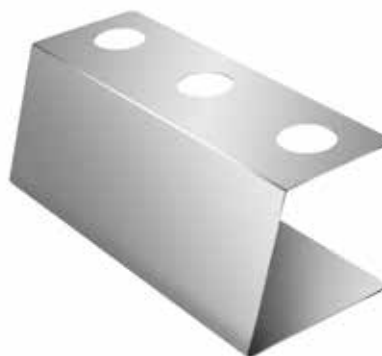

Stresa

Servicono gelato a 3 posti, inox
Ice cream server 3 slots, stainless steel

CODICE	EAN	DIMENSIONE
669/3	8014130136753	10x22x9,5 cm



Ponte

Servicono gelato a 2 posti, inox
Ice cream server 2 slots, stainless steel

CODICE	EAN	DIMENSIONE
609/2	8014130240399	8,5x13x7 cm

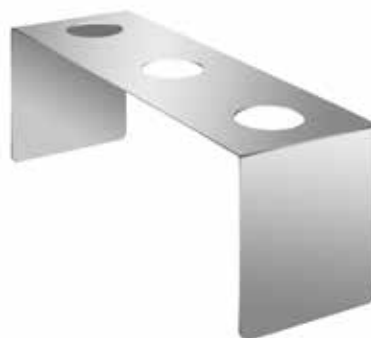

Ponte

Servicono gelato a 3 posti, inox
Ice cream server 3 slots, stainless steel

CODICE	EAN	DIMENSIONE
609/3	8014130244412	8,5x22x7 cm

Ice cream shop accessories



Spatulas, serving dishes and cone, these are the essential tools in every ice cream shop to offer a complete and accurate service. Made entirely of stainless steel, they are also easy to clean and guarantee quality and resistance over time.



Servicono gelato spirale a 1 posto, inox
Ice cream spiral server 1 slot, stainless steel

CODICE	EAN	DIMENSIONE
500/1	8014130244939	Ø10,5x13 cm



Piatto cassata, inox
Cassata dish, stainless steel

CODICE	EAN	DIMENSIONE
166	8014130007657	Ø15 cm

Disponibile in vari colori
Available in different colors



Servicono gelato spirale, inox
Ice cream spiral server, stainless steel

CODICE	EAN	POSTI	DIMENSIONE
500/2	8014130003659	2	ø23X17 cm
500/3	8014130003680	3	ø23X17 cm
500/4	8014130002003	4	ø23X17 cm
500/5	8014130003697	5	ø23X17 cm



Spatola professionale da gelateria
in acciaio e manico ergonomico in
acrilico trasparente
Ice cream server, stainless steel and
transparent acrylic handle

CODICE	EAN	DIMENSIONE
160	8014130500776	26 cm



Portatovaglioli

Napkin holders:

- Portatovaglioli
Napkin holders
- Porta bustine
Sachet holders

Portatovaglioli

 Grazie al contributo di due designer, Cerutti Inox offre un'assortita gamma di portatovaglioli e porta bustine, che sapranno decorare e regalare stile e praticità alla tavola del vostro locale. Realizzati in acciaio inox, sono resistenti e di facile pulizia.



Alessia

Designed by
Liana Cavallaro

Portatovaglioli in acciaio inox
Napkin holder made of stainless steel

CODICE	EAN	DIMENSIONE
986/18	8014130009026	12,6X18x4 cm
986/22	8014130009040	12,6x22x4 cm



Spot

Designed by
Itamar Harari

Portatovaglioli in acciaio inox
Napkin holder made of stainless steel

CODICE	EAN	DIMENSIONE
SPOT100	8014130013009	7,5x15,3x3 cm



Cubic

Designed by
Itamar Harari

Portatovaglioli in acciaio inox
Napkin holder made of stainless steel

CODICE	EAN	DIMENSIONE
CUB0200	8014130013061	13x19x8,3 cm

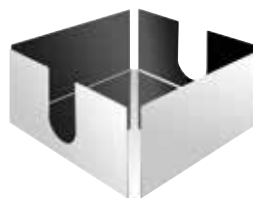

Cusio

Portatovaglioli quadro alto, in inox
Napkin holder made of stainless steel

CODICE	EAN	DIMENSIONE
607/14	8014130233728	9,5x14x14 cm
607/18	8014130233742	9,5x18x18 cm
607/22	8014130233766	9,5x22x22 cm

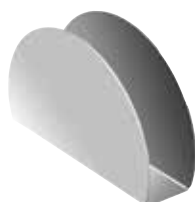

Portatovaglioli in acciaio inox
Napkin holder made of stainless steel

CODICE	EAN	DIMENSIONE
603	8014130244175	10,5x7x2,5 cm



Portatovaglioli in acciaio inox
Napkin holder made of stainless steel

CODICE	EAN	DIMENSIONE
30	8014130003109	8x12x7,5 cm



Stresa

Portatovaglioli quadro, in inox
Napkin holder made of stainless steel

CODICE	EAN	DIMENSIONE
666/14	8014130245073	5x14x14 cm
666/18	8014130240337	5x18x18 cm
666/22	8014130240351	5x22x22 cm



Cusio

Portatovaglioli quadro, in inox
Napkin holder made of stainless steel

CODICE	EAN	DIMENSIONE
606/14	8014130244977	5x14x14 cm
606/18	8014130244991	5x18x18 cm
606/22	8014130245011	5x22x22 cm

Napkin holders



Thanks to the contribution of two designers, Cerutti Inox offers an assorted range of napkin holders and sachets, which will decorate and give style and practicality to the table in your restaurant. Made of stainless steel, they are resistant and easy to clean.



Cubic
Designed by
Itamar Harari

Portabustine in acciaio inox
Sachet holder made of stainless steel

CODICE	EAN	DIMENSIONE
CUB0155	8014130013108	4,2x12x6 cm



**Cusio
2 piani**

Portabustine in acciaio inox
Sachet holder made of stainless steel

CODICE	EAN	DIMENSIONE
605	8014130244953	18,5x21x21 cm

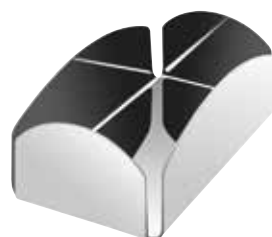

Stresa

Portabustine in acciaio inox
Sachet holder made of stainless steel

CODICE	EAN	DIMENSIONE
664	8014130245035	4,2x12x6,8 cm



**Stresa
2 piani**

Portabustine in acciaio inox
Sachet holder made of stainless steel

CODICE	EAN	DIMENSIONE
665	8014130245059	18,5x21x21 cm



Cusio

Portabustine in acciaio inox
Sachet holder made of stainless steel

CODICE	EAN	DIMENSIONE
604	8014130233780	4,2x12x6,8 cm

Colonnine porta gel:

Column for gel

- Colonnina porta gel con supporto
Column for gel with support
- Colonnina porta gel con
supporto e mensola
Column for gel with support and shelf

Colonnine porta gel

Column for gel

Realizzate totalmente in acciaio inossidabile, queste colonnine porta gel, sono robuste e di facile manutenzione, dotate di supporto porta gel e mensola di supporto per guanti o altri accessori, sono indispensabili in ambienti pubblici per garantire la corretta igiene e sicurezza degli ambienti.

Made entirely of stainless steel, these gel holder columns are robust and easy to maintain, equipped with a gel holder support and a support shelf for gloves or other accessories, they are indispensable in public environments to ensure proper hygiene and safety of the environments.



SUPPORTO PORTA GEL

Supporto porta gel in acciaio inossidabile.

Gel holder in stainless steel.



Colonnina portagel con supporto
Column for gel with support

CODICE	EAN	DIMENSIONE	
4010	8014130242171	114,5x34x30 cm	1+0,5 LT
4010/1LT	8014130242195	144,5x34x30 cm	1 LT
4010/0,5LT	8014130242218	144,5x34x30 cm	0,5 LT



Colonnina portagel con supporto e mensola
Column for gel with support and shelf

CODICE	EAN	DIMENSIONE	
4010/M1LT	8014130254693	144,5x34x30 cm	1 LT
4010/M0,5LT	8014130242232	144,5x34x30 cm	0,5 LT



Cerutti Inox

 MADE IN ITALY 

